

# ¿Dónde se puede instalar un MOSQUITERO?

TIPO DE ABERTURA TIPO DE MOSQUITERO	VENTANA BATIENTE U OSCILO-BATIENTE	VENTANA CORREDIZA	PUERTA DE ABRIR	PUERTAS CORREDIZA	PROYECTANTE	BANDEROLA	OBSERVACIONES
CON IMÁN	EXTERIOR	EXTERIOR	<b>NO</b>	<b>NO</b>	<b>NO</b>	EXTERIOR	3 MEDIDAS STANDARD AJUSTABLES, NO A MEDIDA PLÁSTICOS BLANCOS O NEGROS
	HOJA 1	HOJA 8				HOJA 24	
DE BANDAS	<b>NO</b>	<b>NO</b>	EXTERIOR	EXTERIOR	<b>NO</b>	<b>NO</b>	2 MEDIDAS STANDARD AJUSTABLES PRECIO ESPECIAL POR CORTINAS A MEDIDA
ENROLLABLE de 40, 54 y 62,5	PATAGÓNICAS	EXTERIOR EN MOCHETA (MOSQUITERO EN AMBAS HOJAS)	EXTERIOR EN MOCHETA VERTICAL A CADENA (DERECHA O IZQUIERDA)	EXTERIOR EN MOCHETA 1. VERTICAL EN 1 HOJA + CAÑO ADICIONAL	INTERIOR / SEGÚN INSTALACION: 1. A EJE DE PARED EN MOCHETA INTERIOR	<b>NO</b>	
	HOJA 2, 3 y 4			HOJA 16			
	EXTERIOR EN MOCHETA			2. HORIZONTAL ENGANCHADA EN 1 HOJA	2. A FILO DE PARED INTERIOR MOSQUITERO ATORNILLADO DE FRENTE + CAÑO 25x25 ABAJO		
	HOJA 5 y 6	HOJA 9	HOJA 11	HOJA 17	HOJA 23		
HORIZONTAL ENROLLABLE MANUAL	EXTERIOR EN MOCHETA	<b>NO</b>	EXTERIOR EN MOCHETA - SIMPLE	EXTERIOR EN MOCHETA EN 1 HOJA + CAÑO ADICIONAL	<b>NO</b>	<b>NO</b>	GUÍA SUPERIOR DE 60 mm GUÍA INFERIOR DE 42 mm MEDIDAS MÁXIMAS: 1100 x 2300 mm (SIMPLE) 2200 X 2500 mm (DOBLE)
			HOJA 12				
			EXTERIOR EN MOCHETA - DOBLE				
			HOJA 13	HOJA 18			
PLEGABLE 40 mm HORIZONTAL	<b>NO</b>	<b>NO</b>	EXTERIOR EN TODA LA ABERTURA	EXTERIOR	<b>NO</b>	<b>NO</b>	MEDIDA MÁXIMA POR MOSQUITERO: 1800 x 2500 mm LA ALTURA DE CADA PUERTA DEBE SER SIEMPRE MAYOR EN AL MENOS 200 mm A LA MEDIDA DEL ANCHO TAMBIEN SE INSTALA EN GALERIAS
				HOJA 19			
				2. EN TODA LA ABERTURA			
			HOJA 14	HOJA 20 y 21			
FIJO	EXTERIOR	EXTERIOR (MOSQUITERO EN AMBAS HOJAS)	<b>NO</b>	<b>NO</b>	<b>NO</b>	EXTERIOR	VENDEMOS LA TELA MOSQUITERA DE FIBRA DE VIDRIO CON PVC (GRIS O NEGRA) PARA SU FABRICACIÓN
CORREDIZO	<b>NO</b>	EN 1 HOJA	EN 2 HOJAS	EN 1 HOJA	<b>NO</b>	<b>NO</b>	

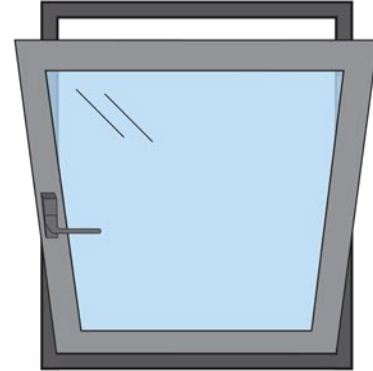
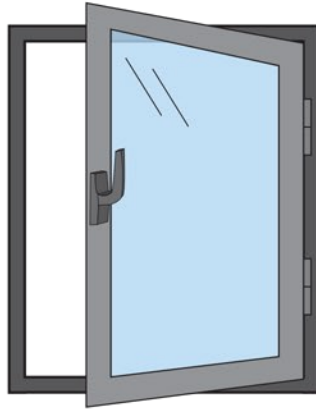
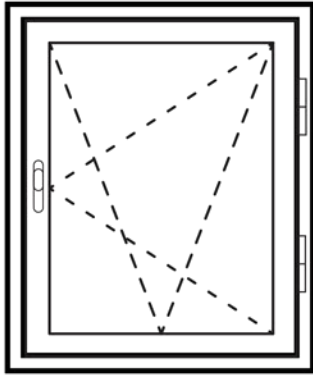

Hay posibilidad de instalar 3 tipos de mosquiteros: CON IMÁN, ENROLLABLE VERTICAL Y ENROLLABLE HORIZONTAL MANUAL, además del fijo.

## CON IMÁN

Se instala en la abertura completa, del lado exterior.

### CORTE HORIZONTAL

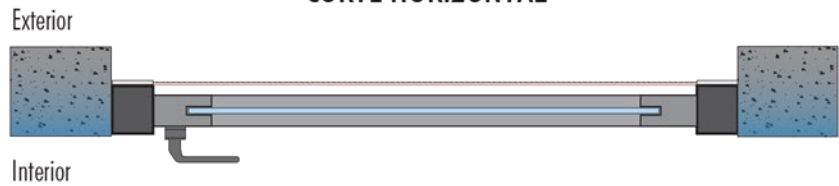

### EXTERIOR

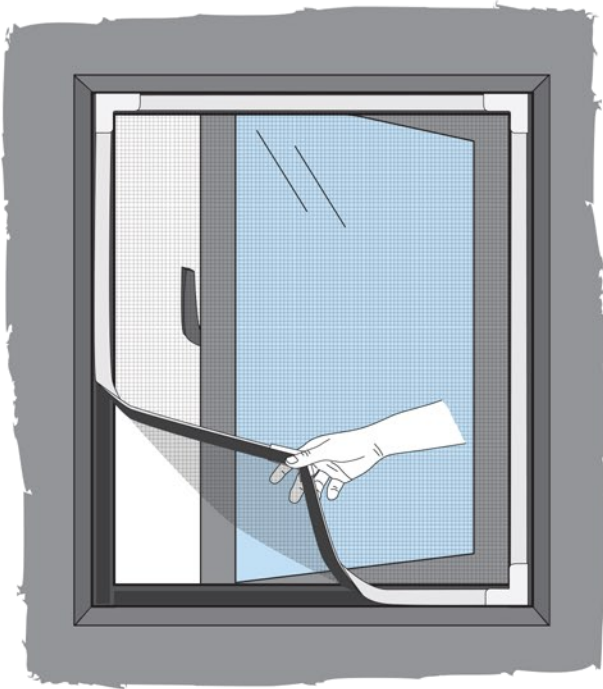

### CORTE VERTICAL

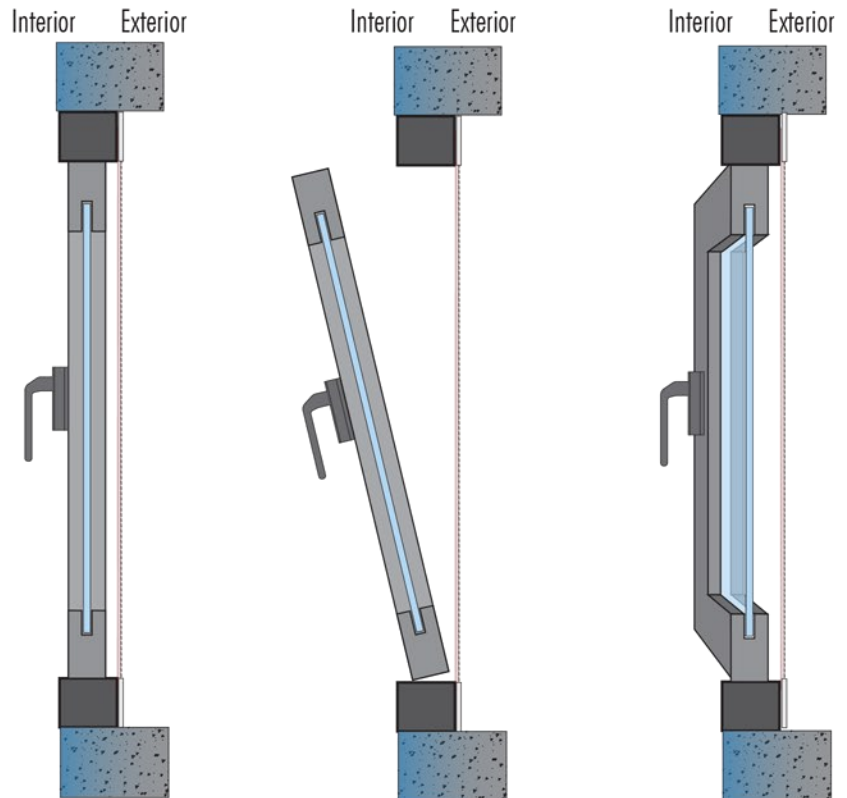

ENROLLABLE VERTICAL - con perfil inferior invertido

VENTANAS PATAGÓNICAS

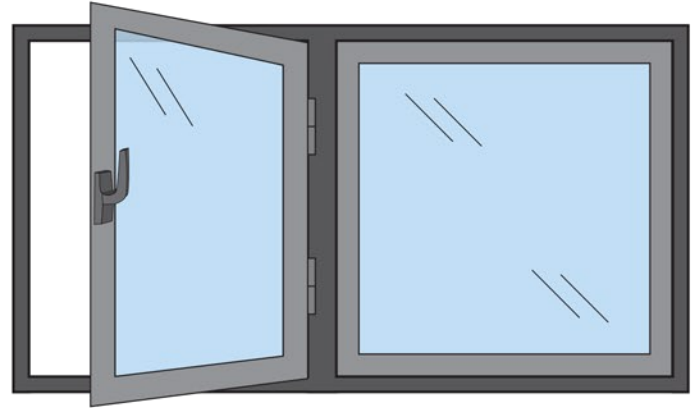
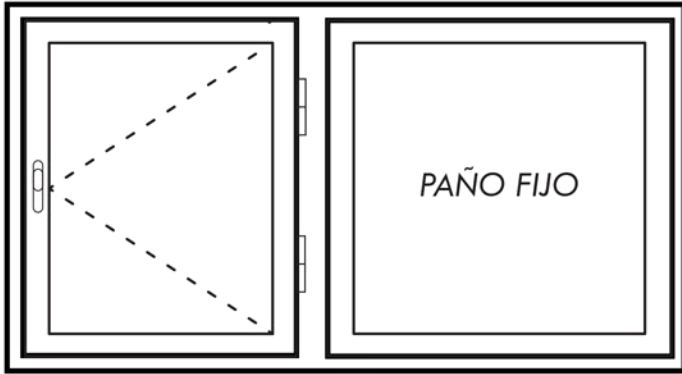

CORTE HORIZONTAL

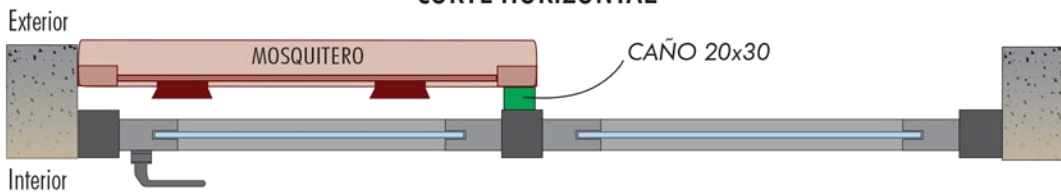

CORTE VERTICAL

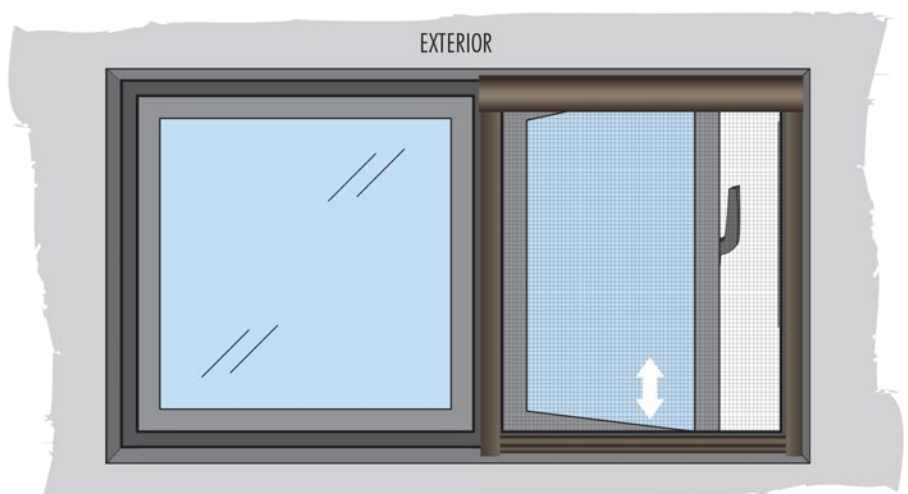
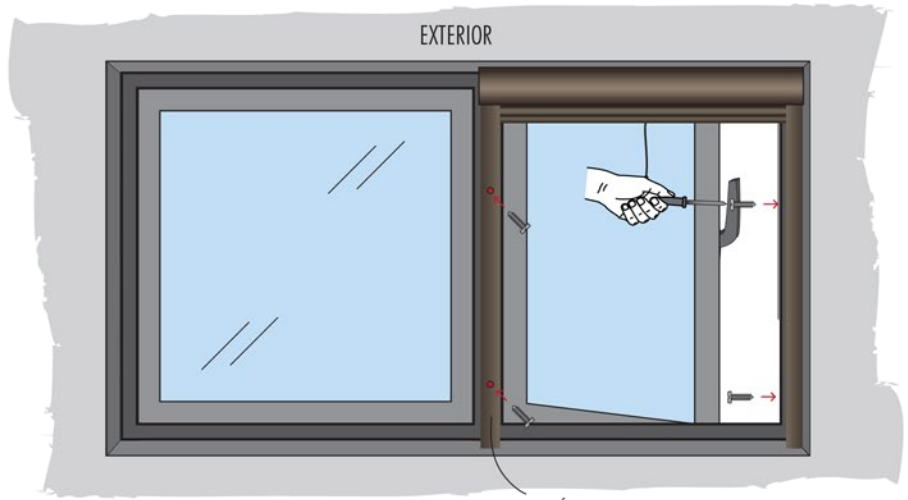
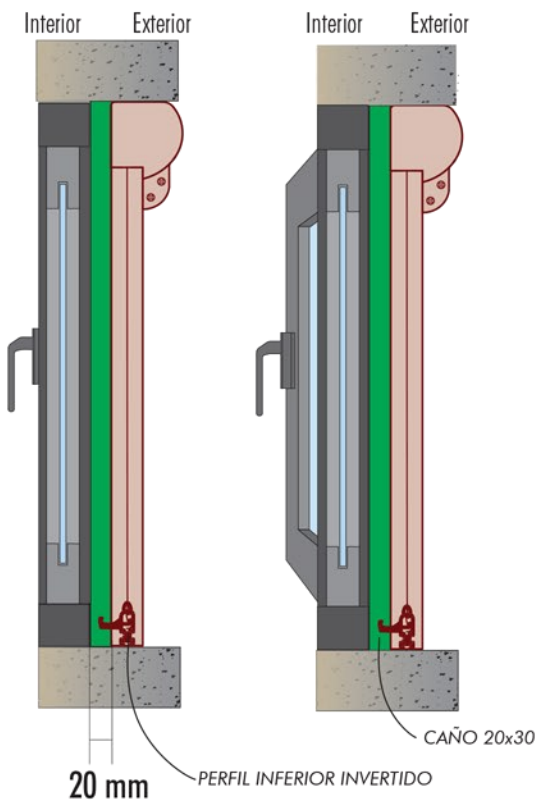

ENROLLABLE VERTICAL - con perfil inferior invertido

VENTANAS PATAGÓNICAS

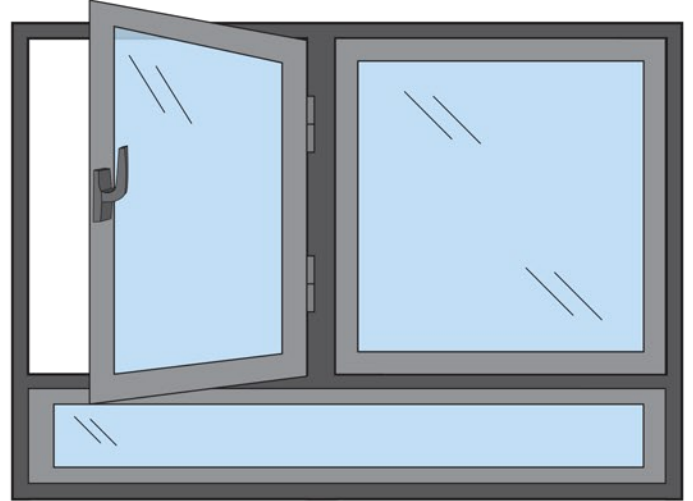
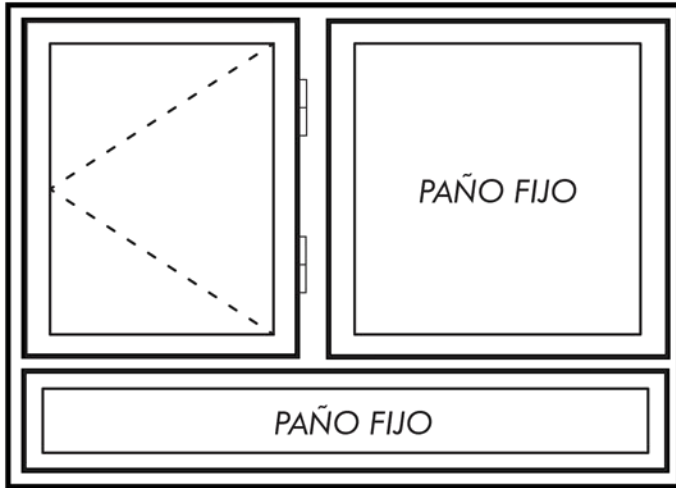

CORTE HORIZONTAL

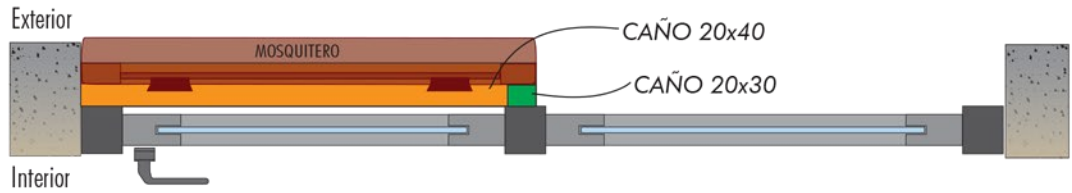

CORTE VERTICAL

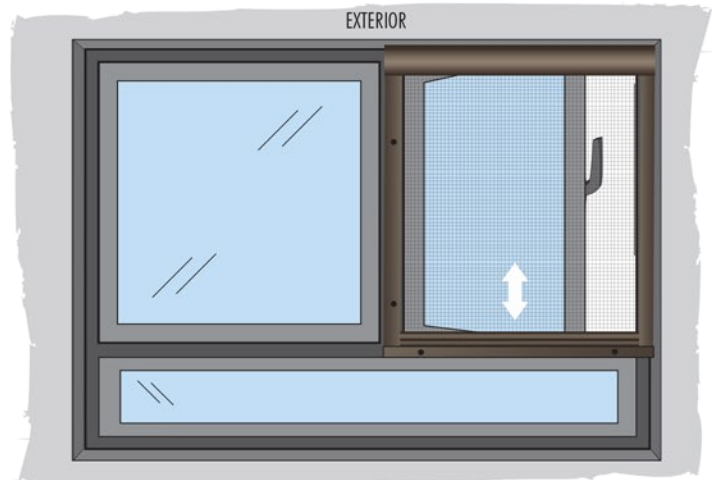
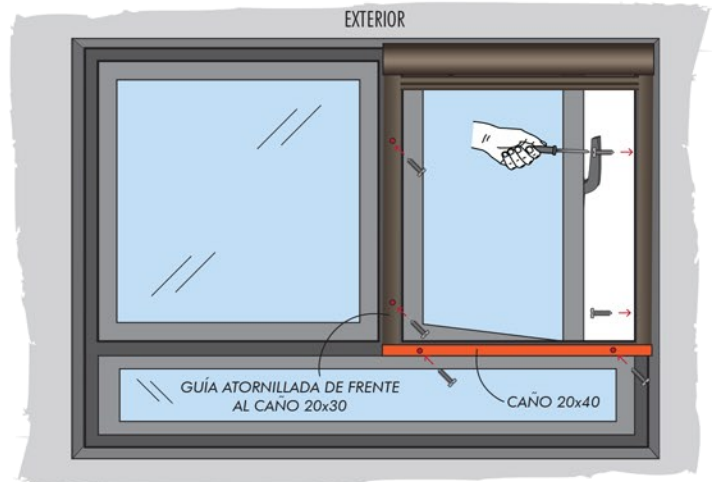
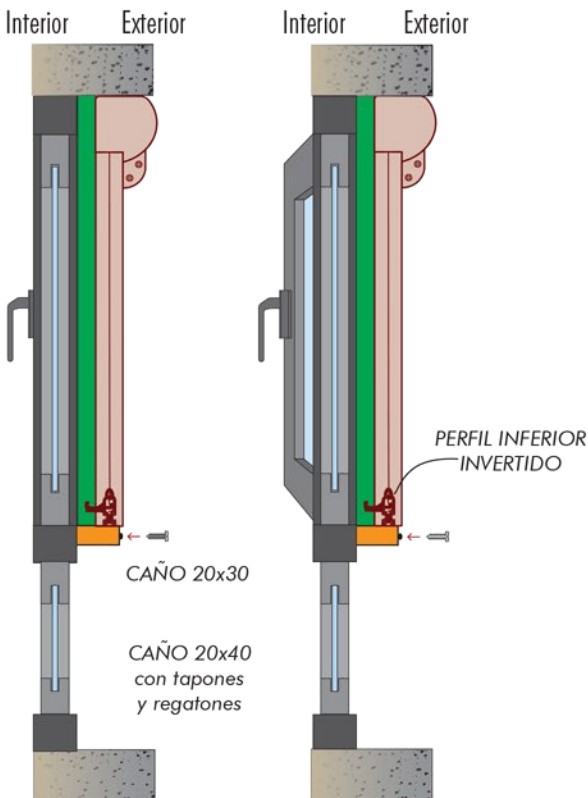

ENROLLABLE VERTICAL - con perfil inferior invertido

VENTANAS PATAGÓNICAS

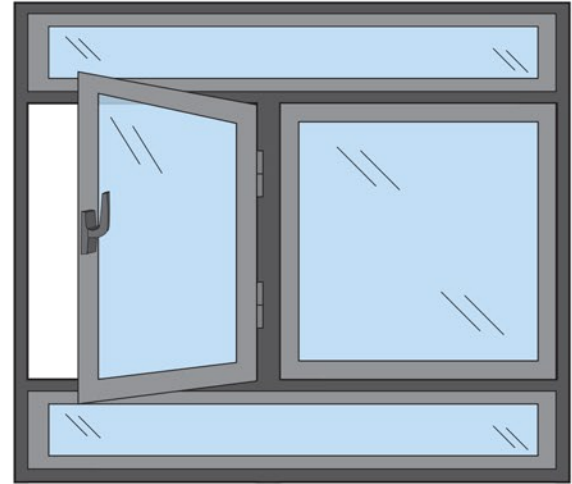
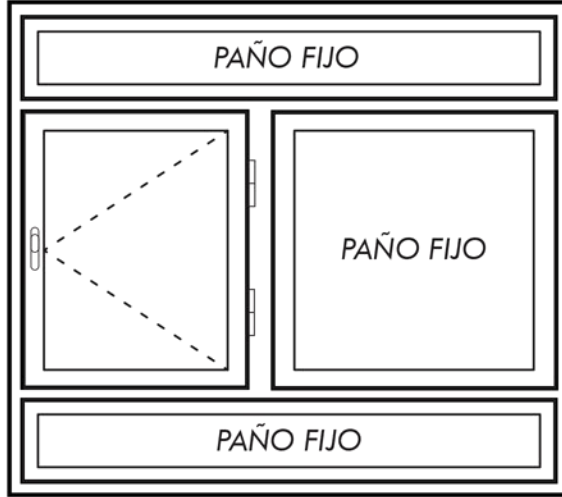

CORTE HORIZONTAL

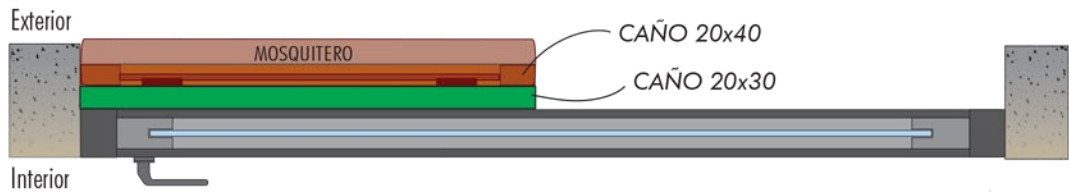

CORTE VERTICAL

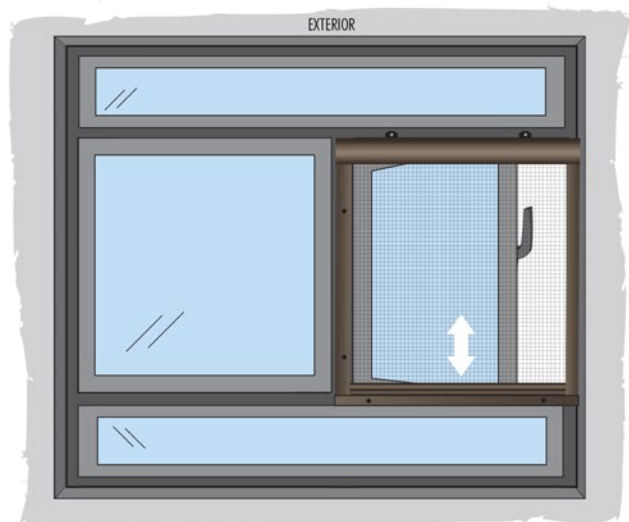
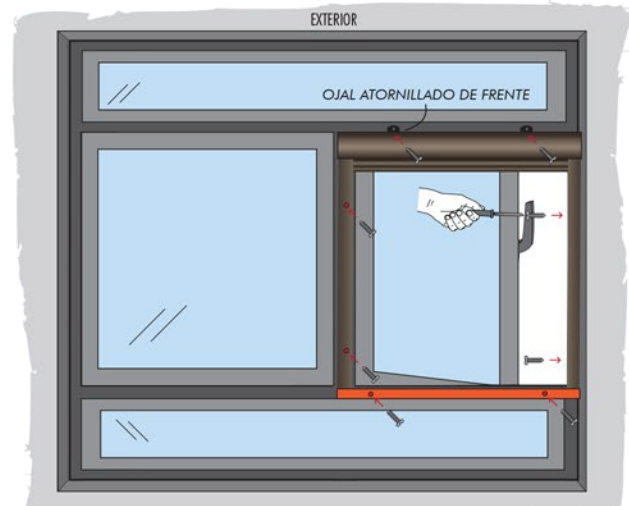
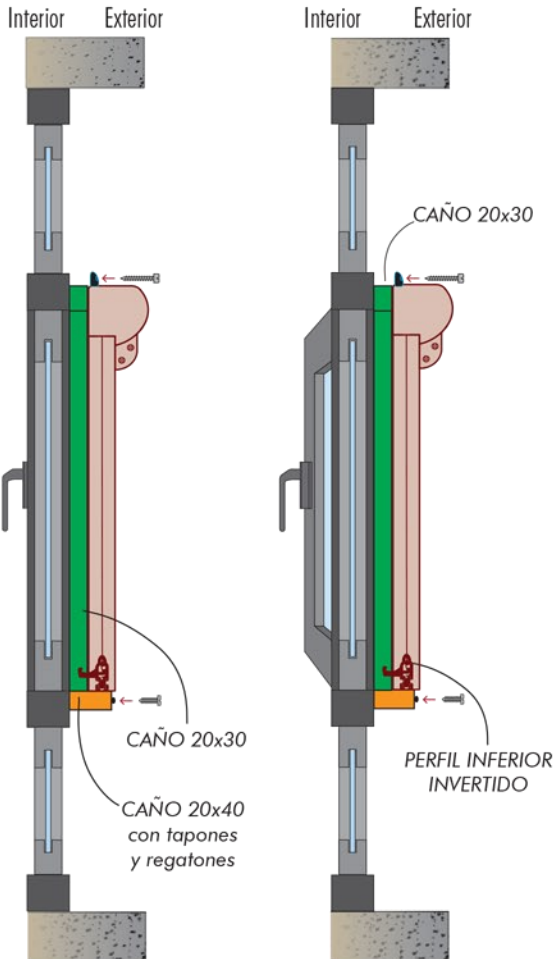

ENROLLABLE VERTICAL - frente mirando al exterior

Se instala en la abertura completa, del lado exterior.  
Se puede manejar de adentro o de afuera.

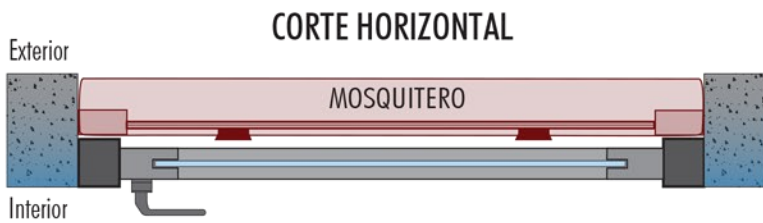

EXTERIOR

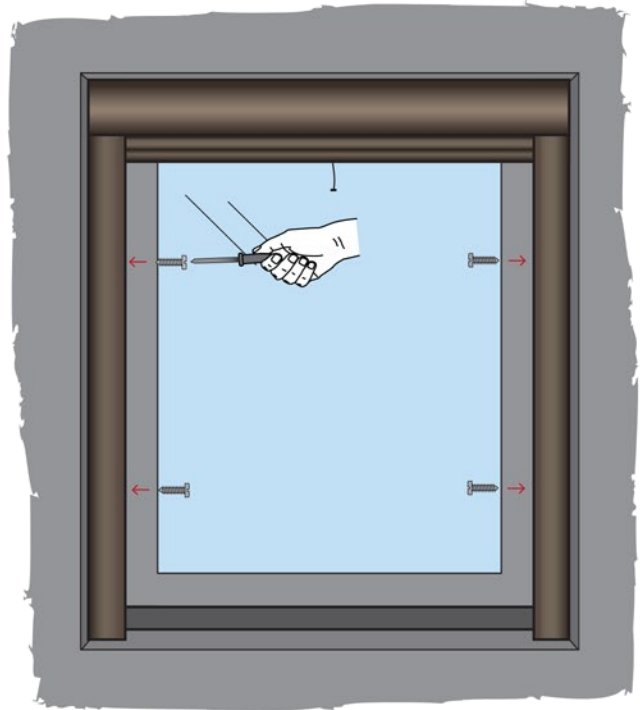

**CORTE VERTICAL**

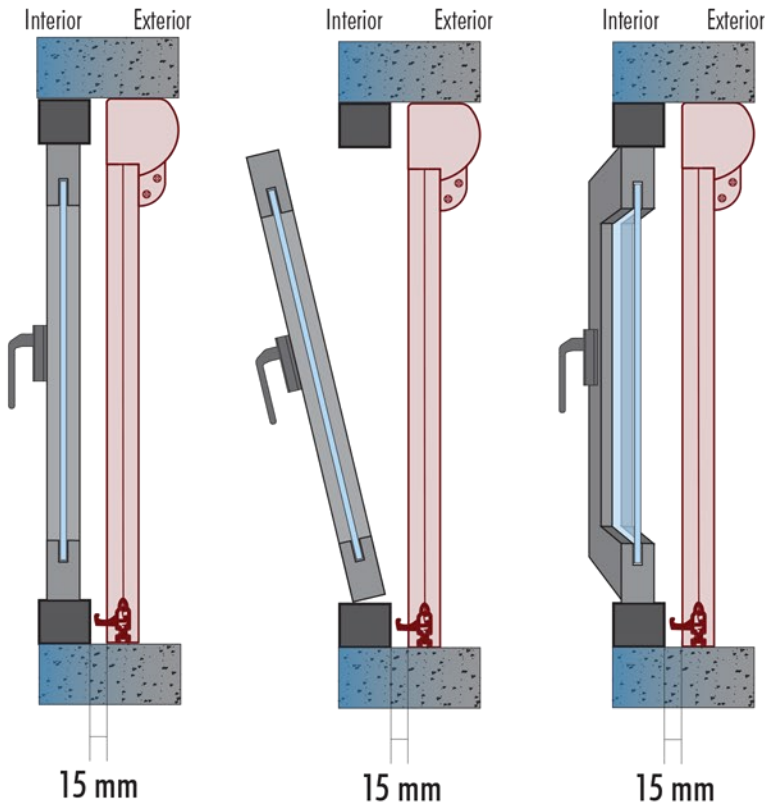

EXTERIOR

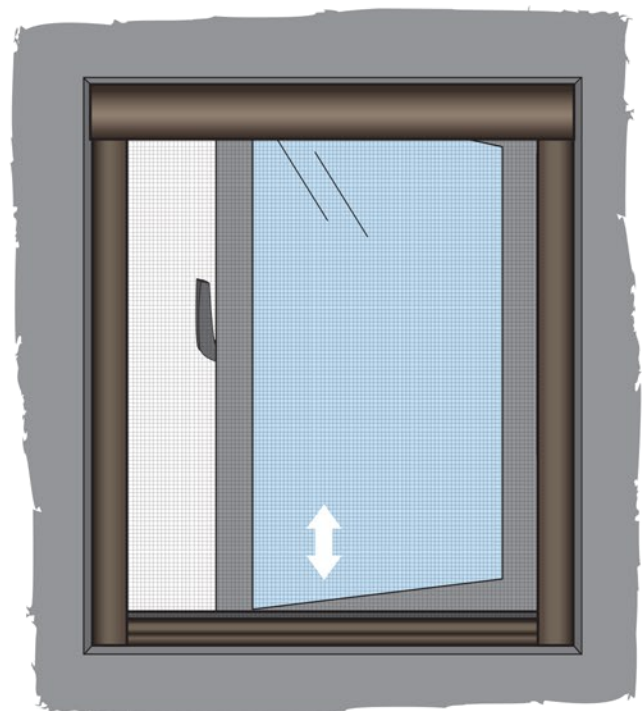

ENROLLABLE VERTICAL - frente mirando al interior

Se instala en la abertura completa, del lado exterior.  
Se puede manejar de adentro o de afuera.

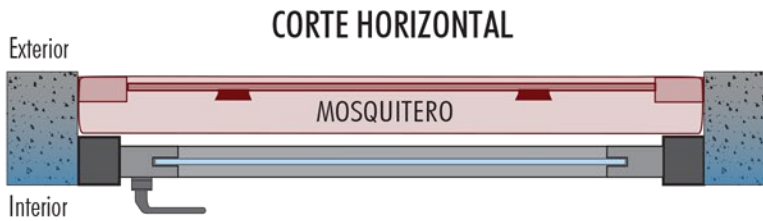

CORTE VERTICAL

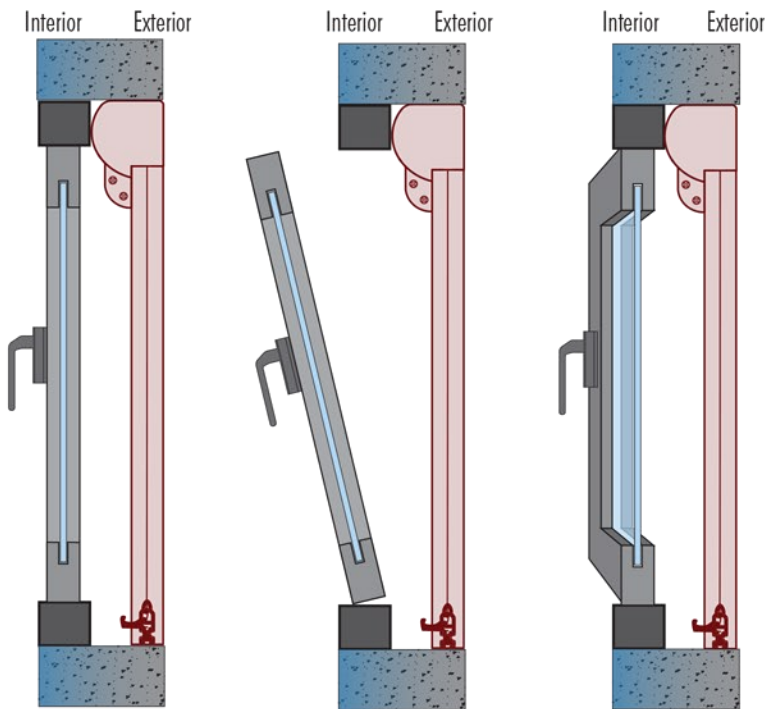

EXTERIOR

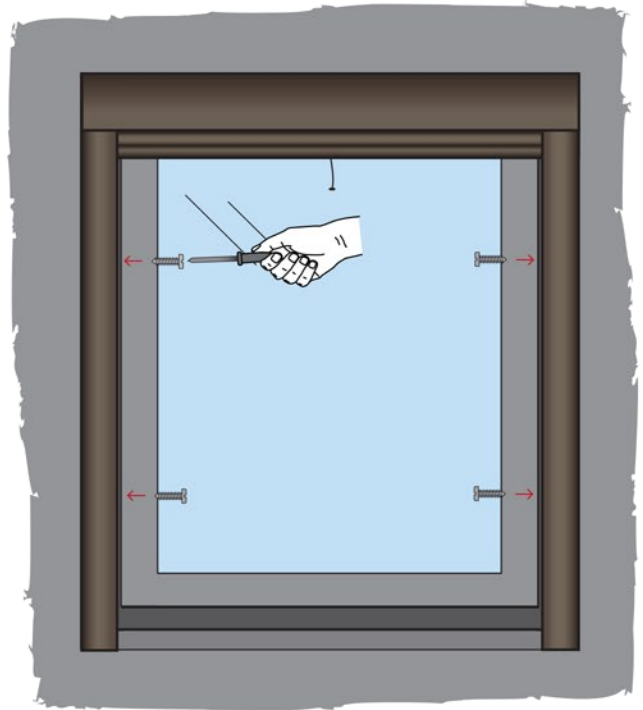

EXTERIOR

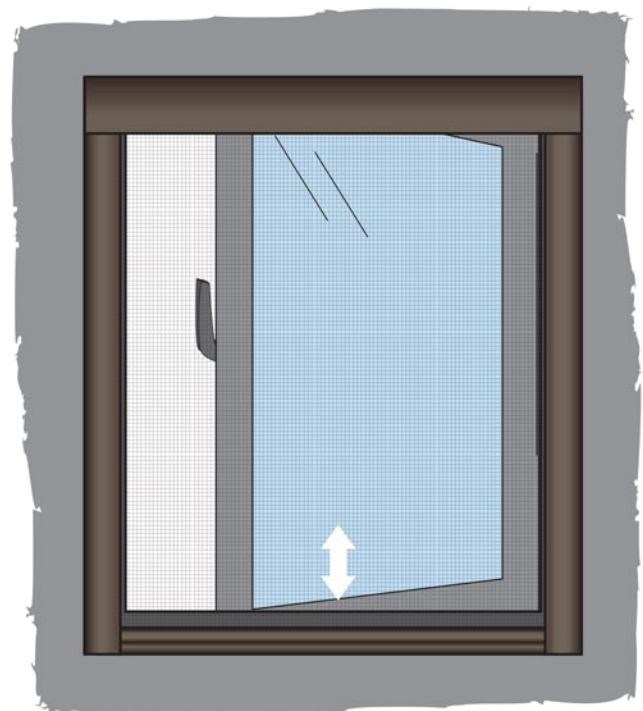

ENROLLABLE HORIZONTAL MANUAL

Se instala en la abertura completa, del lado exterior.  
Se puede manejar de adentro o de afuera.

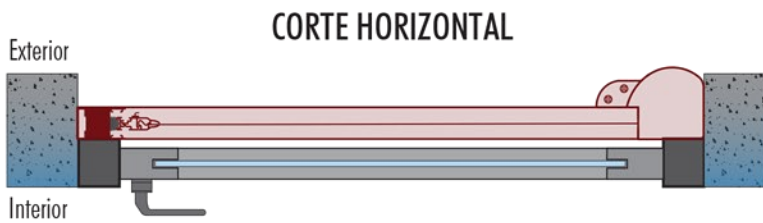

CORTE VERTICAL

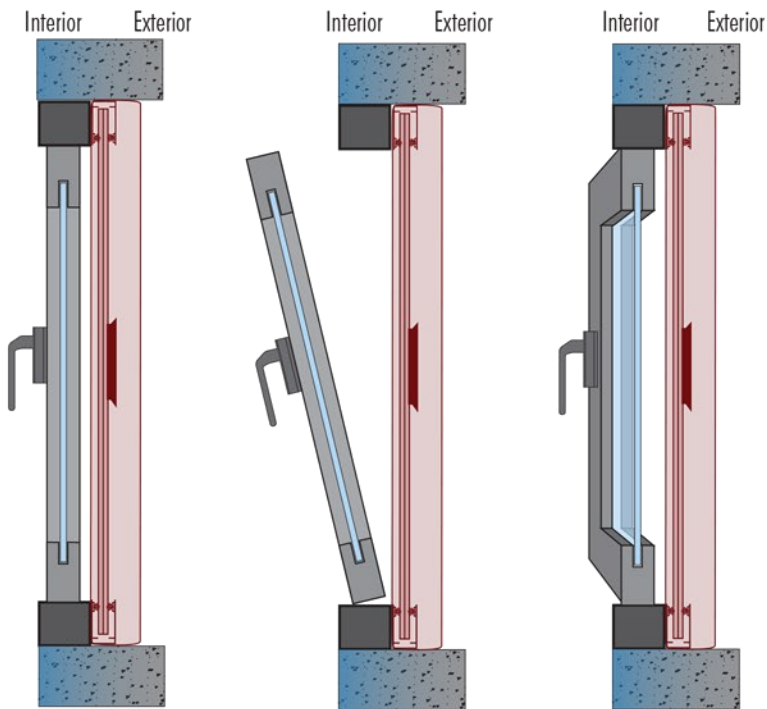

EXTERIOR

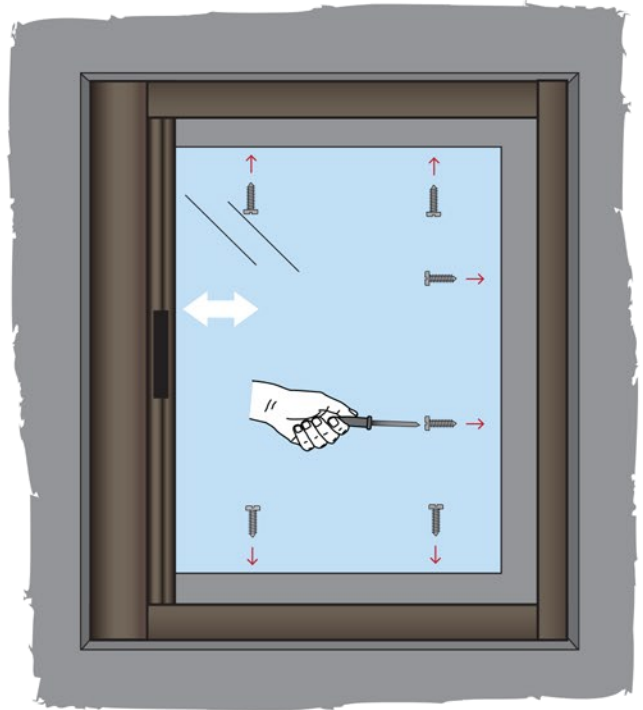

EXTERIOR

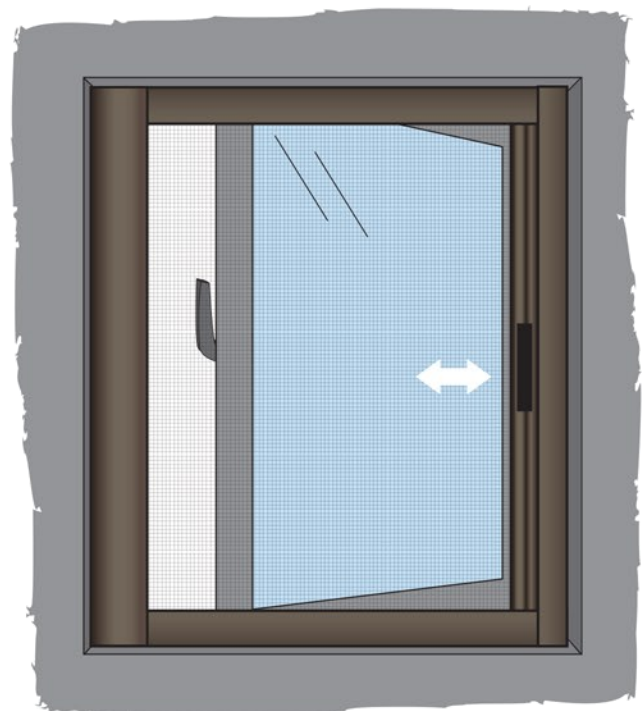



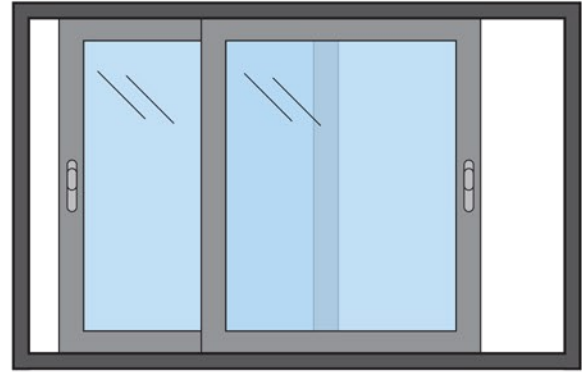
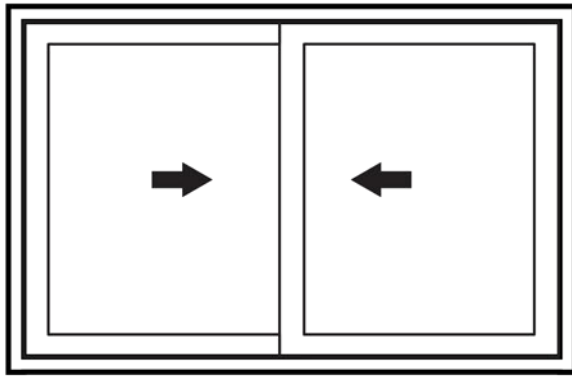

Hay posibilidad de instalar 2 tipos de mosquiteros: CON IMÁN Y ENROLLABLE VERTICAL además de los fijos y corredizos.

CON IMÁN

Se instala en la abertura completa, del lado exterior. En casos excepcionales, se puede instalar en el interior.

CORTE VERTICAL

Interior Exterior

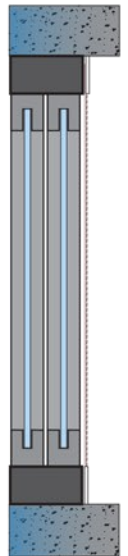

CORTE HORIZONTAL

Exterior

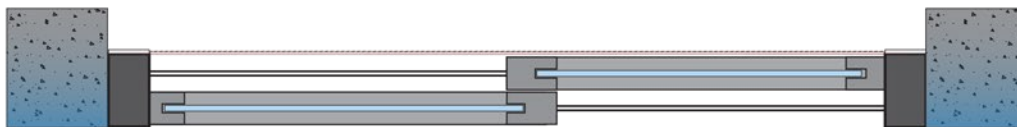

Interior

EXTERIOR

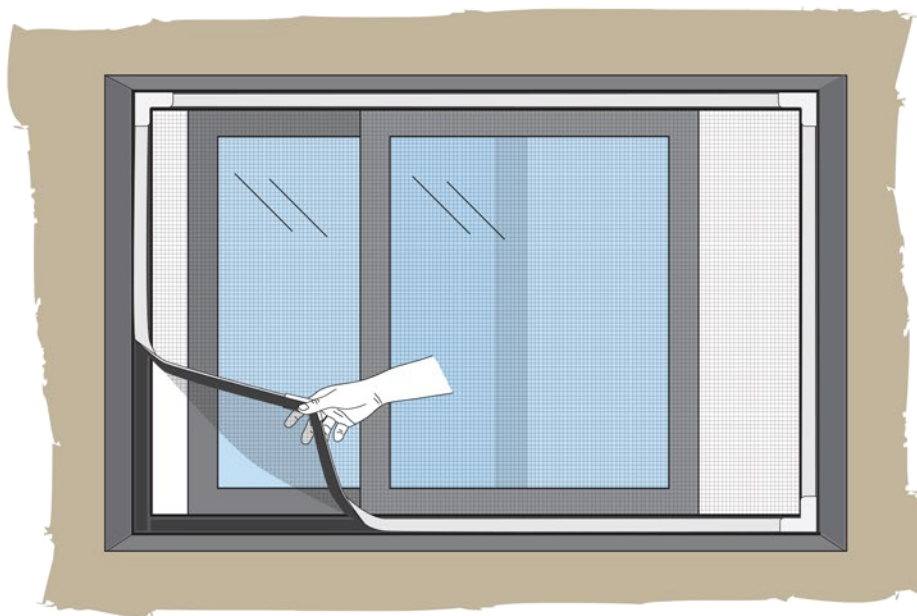

ENROLLABLE VERTICAL

Se instala en la abertura completa, del lado exterior.  
 Se puede manejar de adentro o de afuera.

CORTE HORIZONTAL

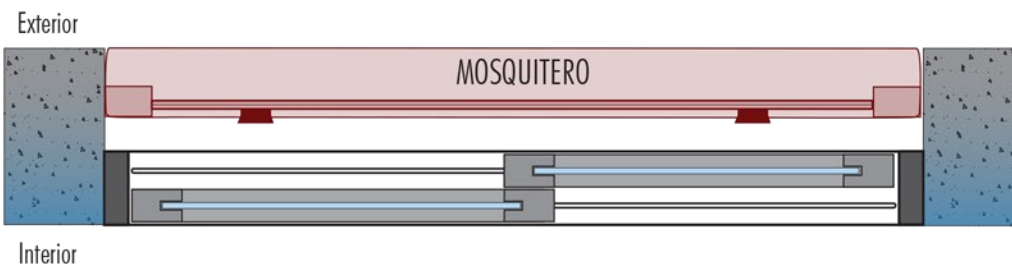

CORTE VERTICAL

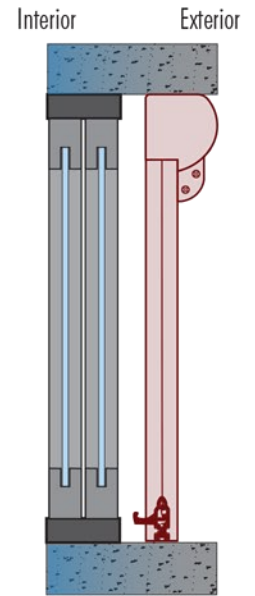

EXTERIOR

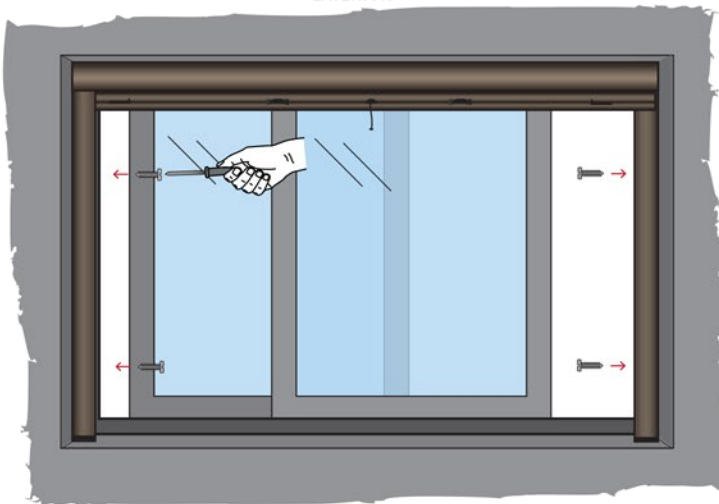

EXTERIOR

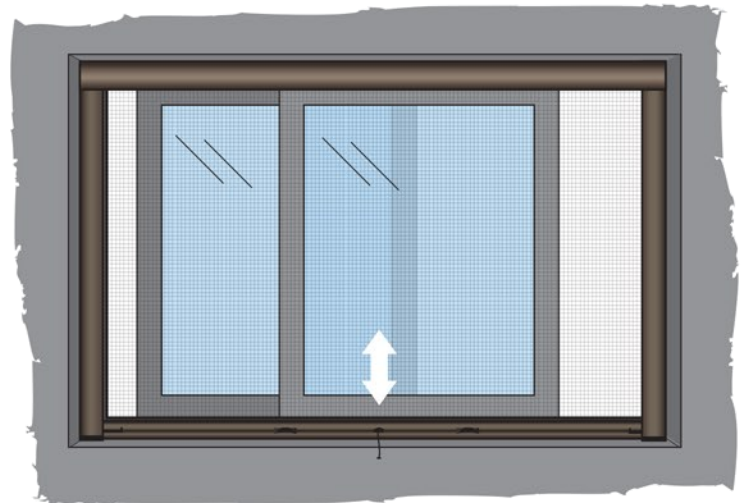

INTERIOR

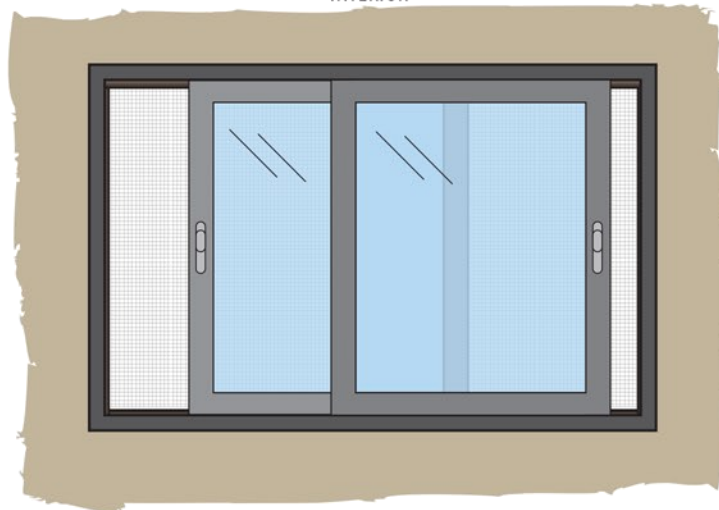

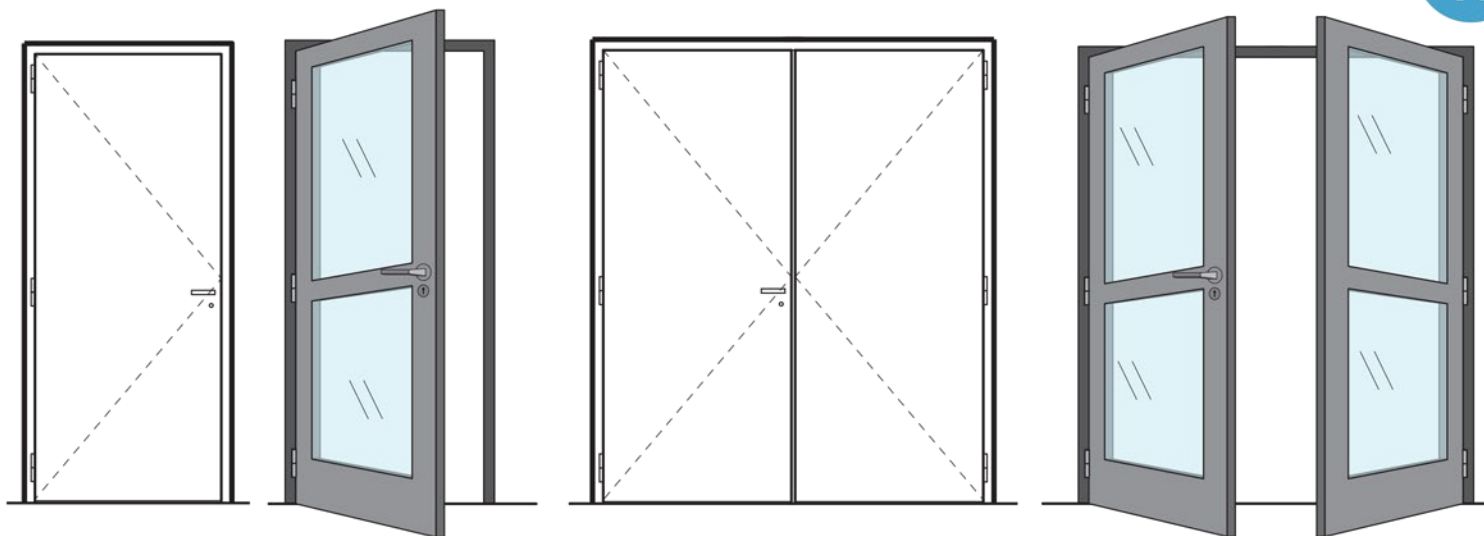

Hay posibilidad de instalar 4 tipos de mosquiteros: DE BANDAS, ENROLLABLE VERTICAL A CADENA, ENROLLABLE HORIZONTAL MANUAL Y PLEGABLE DE 40 mm HORIZONTAL.

DE BANDAS

Se instala en la abertura completa, del lado exterior, en puertas de 1 o de 2 hojas.

CORTE HORIZONTAL

INSTALADO EN MOCHETA



INSTALADO DE FRENTE



Exterior

Exterior - Dos hojas

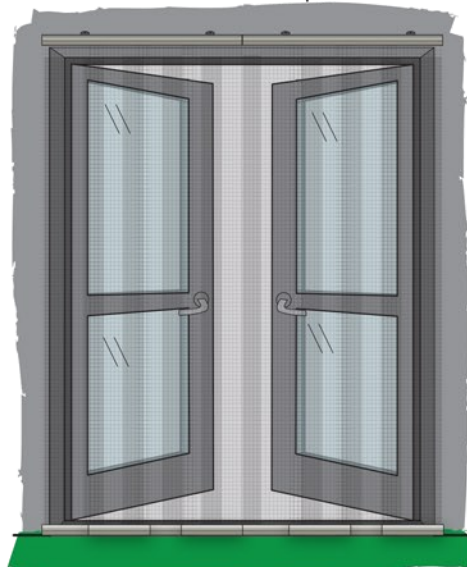
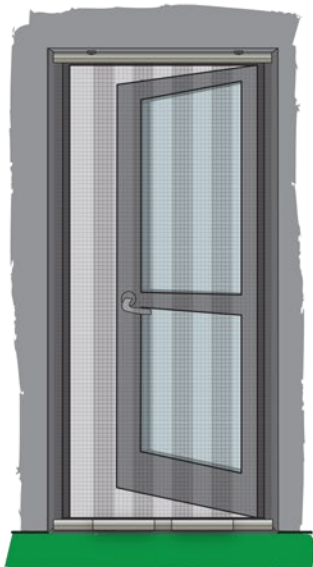

CORTE VERTICAL

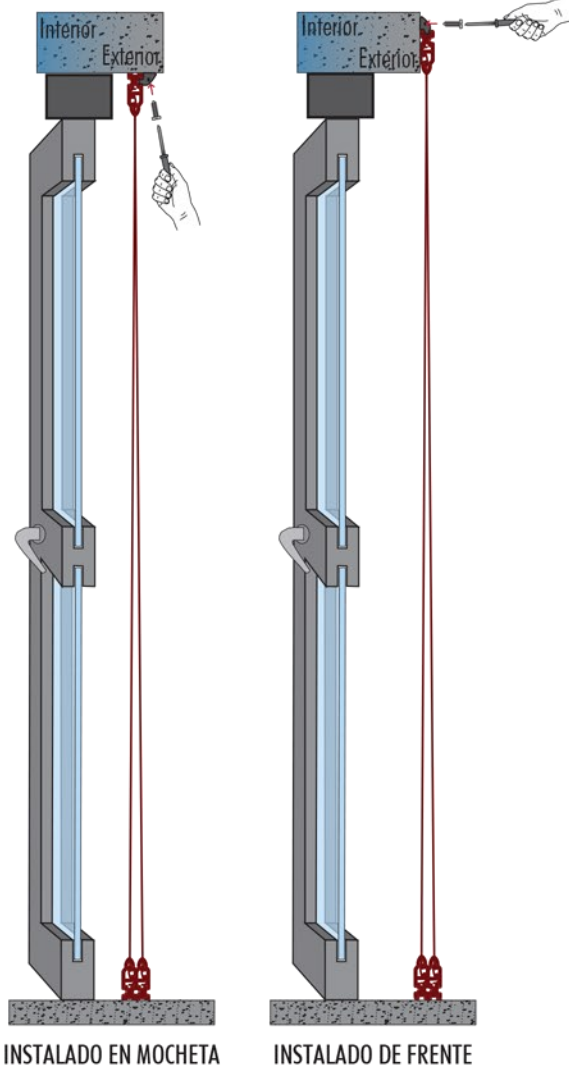

ENROLLABLE VERTICAL A CADENA - derecha o izquierda

Se instala en la abertura completa, del lado exterior en la mocheta. En casos excepcionales, se puede instalar en el interior (si la puerta abre hacia afuera).

CORTE VERTICAL

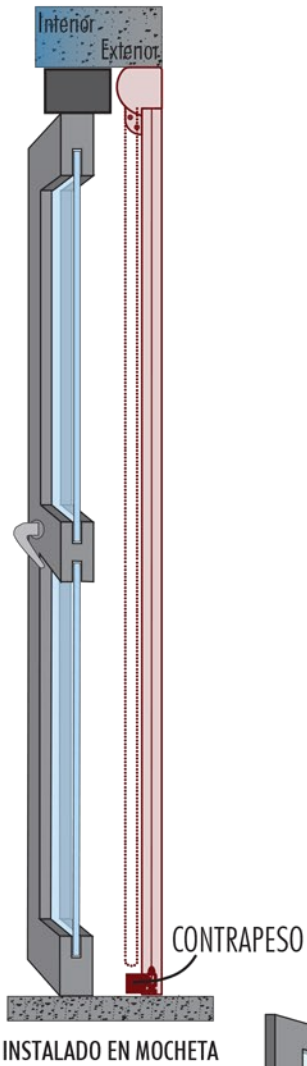

CORTE HORIZONTAL



Exterior - Una hoja

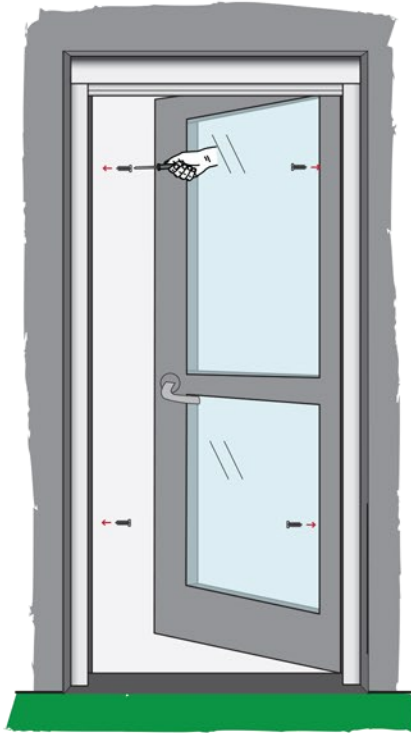

Exterior - Dos hojas

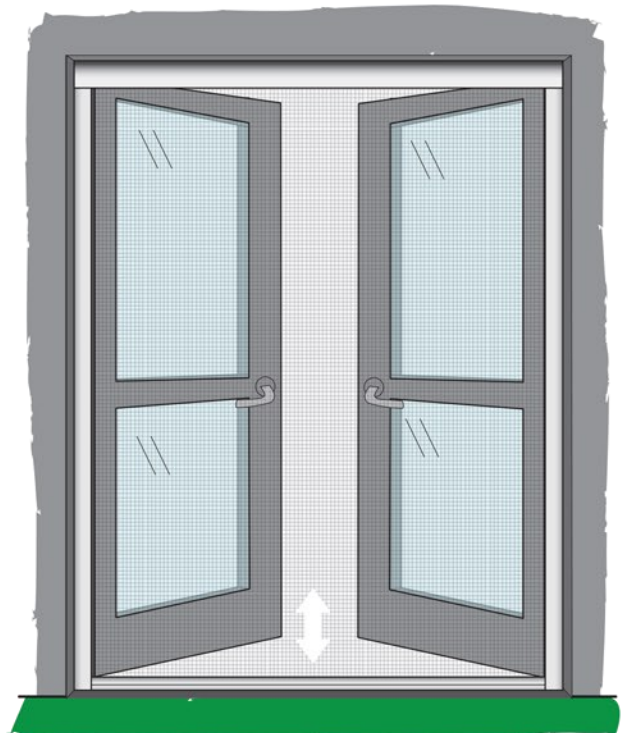

Interior - Una hoja

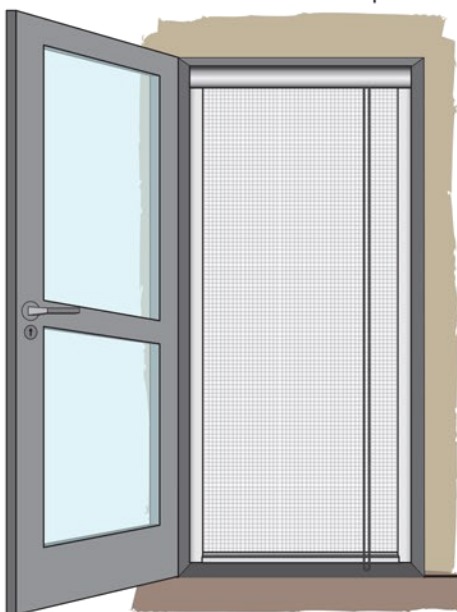

Interior - Dos hojas

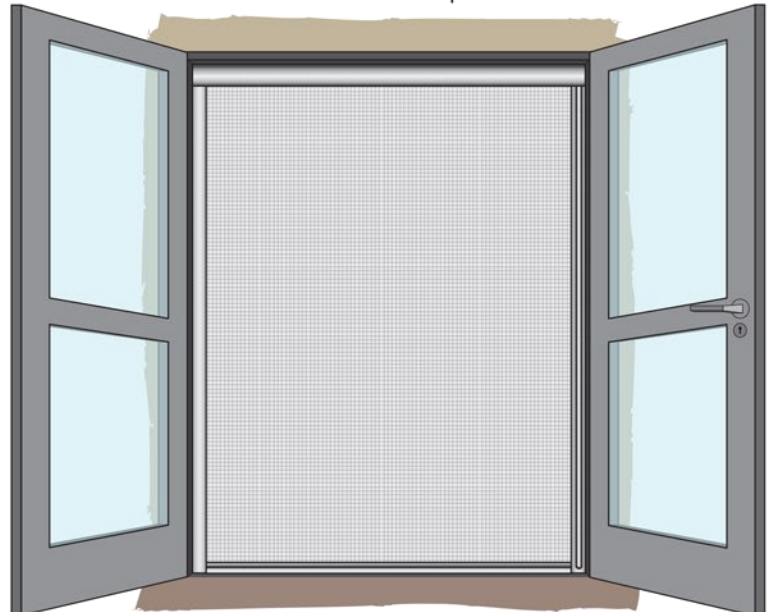

ENROLLABLE HORIZONTAL MANUAL

Se instala en la abertura completa, del lado exterior en la mocheta.  
En casos excepcionales, se puede instalar en el interior (si la puerta abre hacia afuera).

CORTE VERTICAL

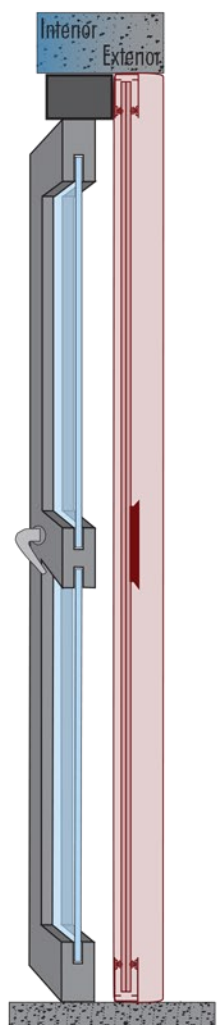

CORTE HORIZONTAL

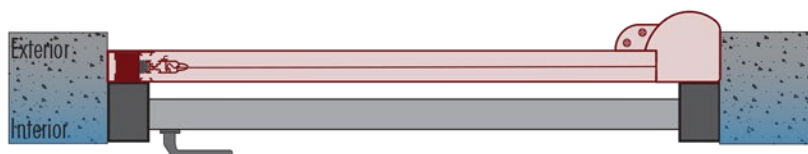

Exterior - Una hoja

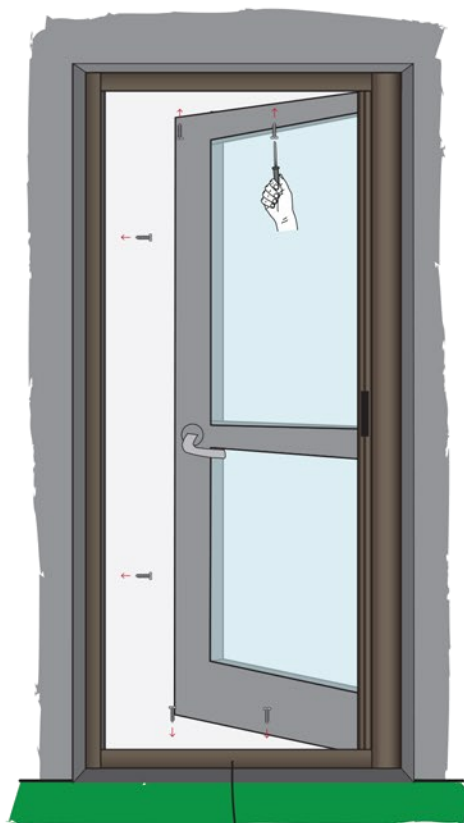

Interior - Una hoja

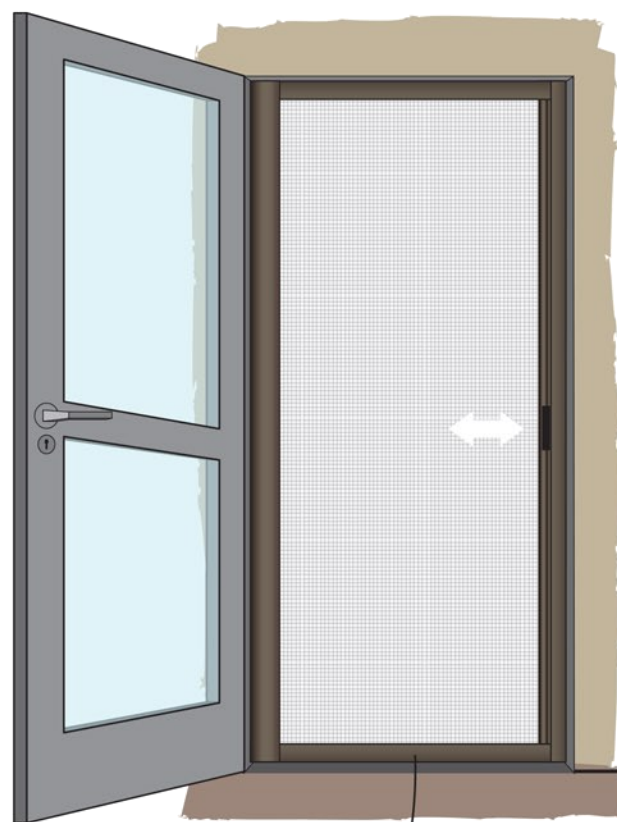

GUÍA INFERIOR DE 42 mm

**ENROLLABLE HORIZONTAL MANUAL - DOBLE**

Se instala en ambas hojas de la abertura, del lado exterior, con el frente del cajón hacia afuera.

En casos excepcionales, se puede instalar en el interior (si la puerta abre hacia afuera).

CORTE HORIZONTAL

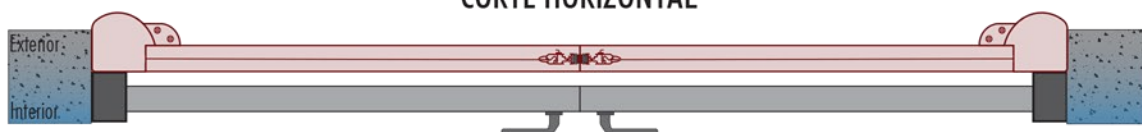

CORTE VERTICAL

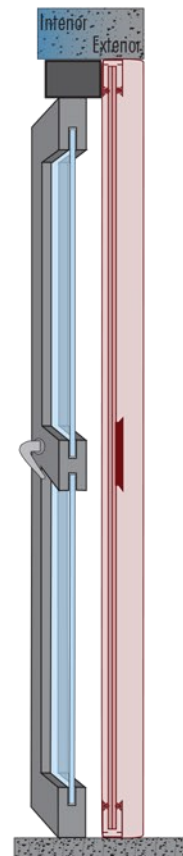

INSTALADO EN MOCHETA

Exterior - Dos hojas



Exterior - Dos hojas



GUÍA INFERIOR DE 42 mm

PLEGABLE DE 40 mm HORIZONTAL

- Medida máxima por hoja de mosquitero: 1800 x 2500 mm (máximo 3600 x 2500 mm)
- La altura de cada puerta mosquitera debe ser siempre mayor en al menos 200 mm a la medida del ancho
- También se instala en galerías

CORTE VERTICAL

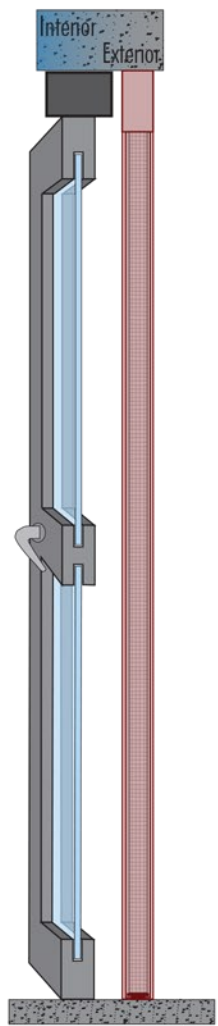

INSTALADO EN MOCHETA

CORTE HORIZONTAL

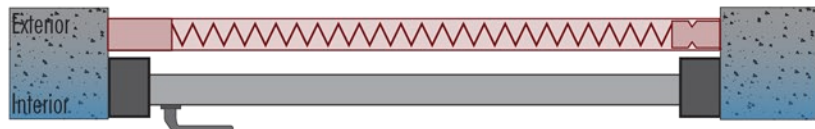

Exterior - Una hoja



Exterior - Dos hojas - Ancho menor a 1800 mm

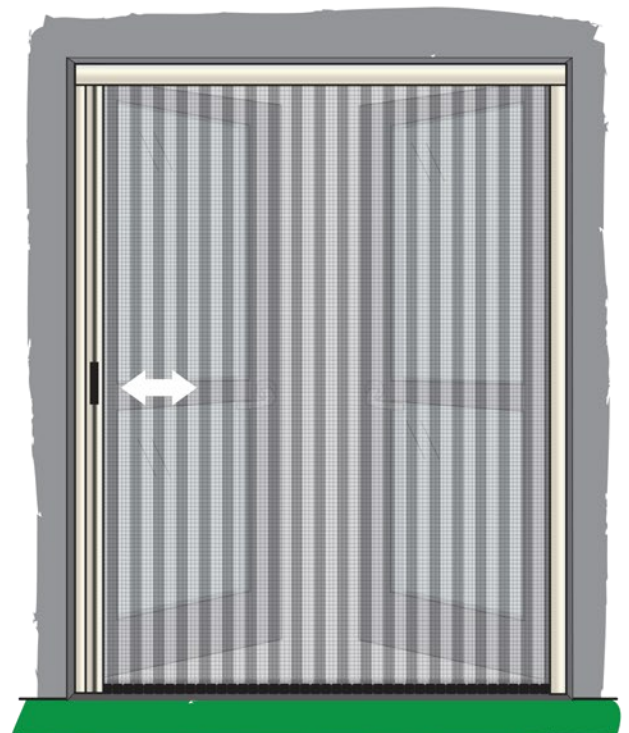

Interior - Dos hojas - De hasta 3600 mm de ancho x 2500 mm de altura

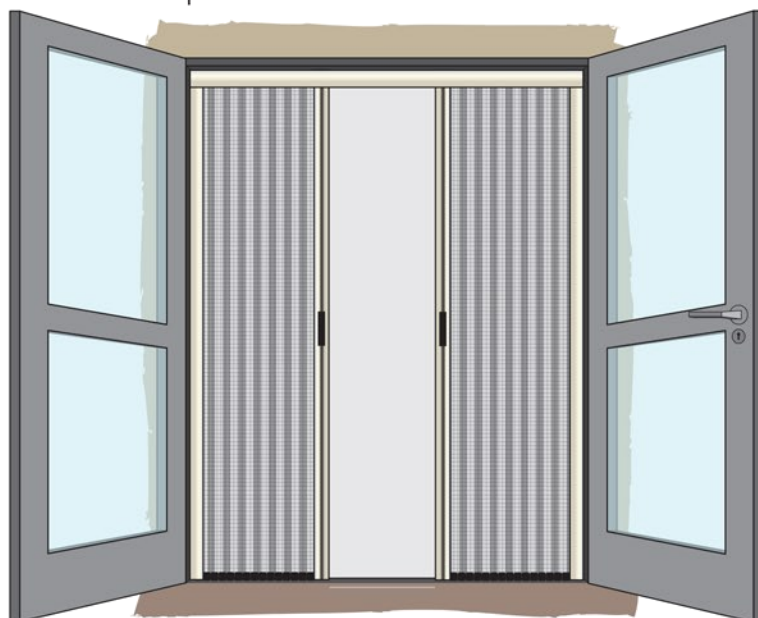

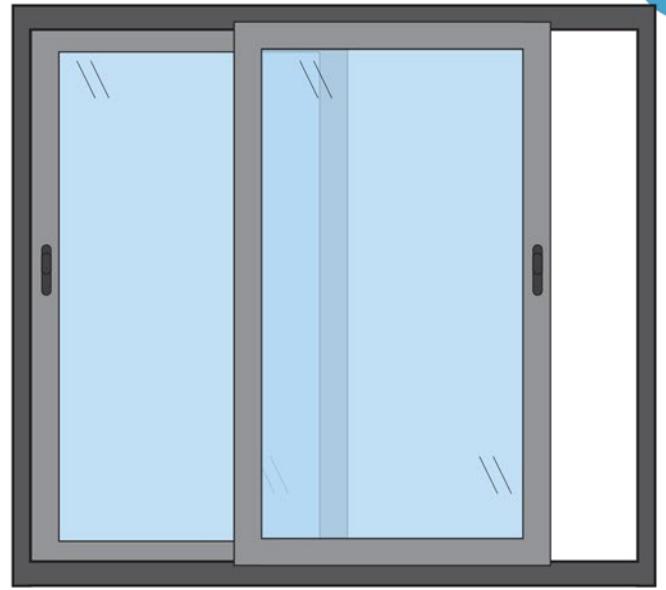
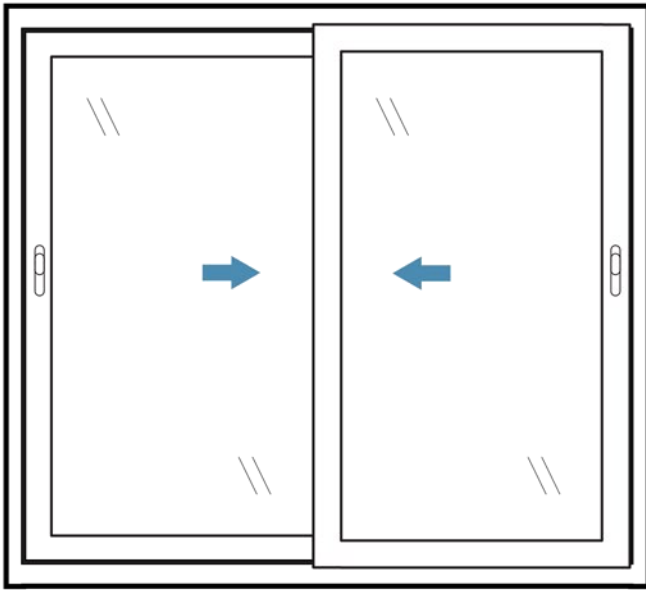

Hay posibilidad de instalar 4 tipos de mosquiteros: DE BANDAS, ENROLLABLE (A RESORTE VERTICAL U HORIZONTAL), ENROLLABLE HORIZONTAL MANUAL Y PLEGABLE DE 40 mm HORIZONTAL, además del corredizo.

## DE BANDAS

Se instala en la abertura completa, del lado exterior.

### CORTE HORIZONTAL

INSTALADO EN MOCHETA

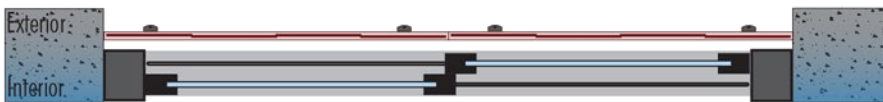

INSTALADO DE FRENTE

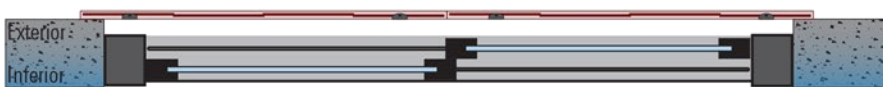

Exterior - Instalado en mocheta

Exterior - Instalado de frente

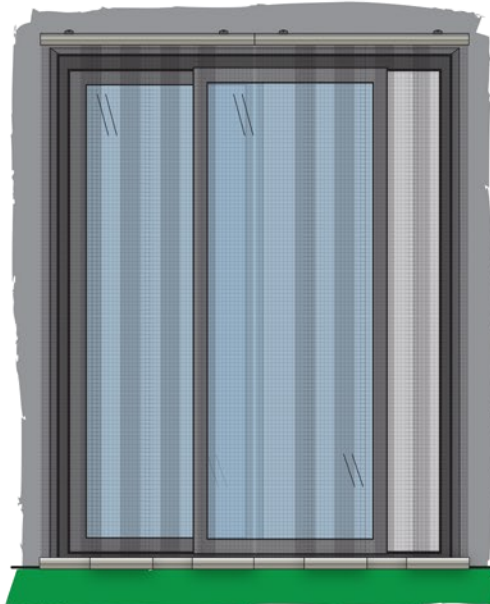
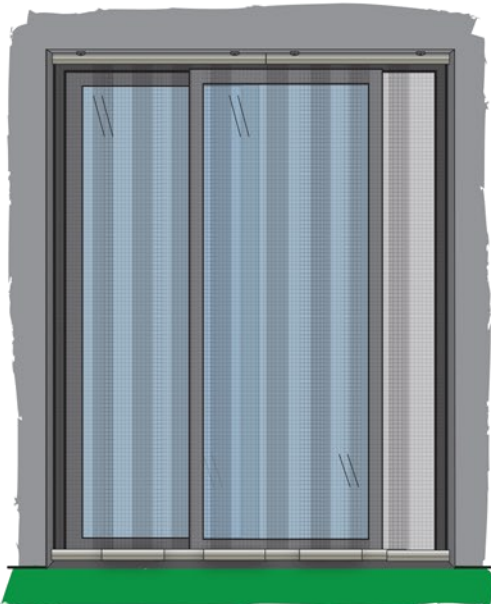

### CORTE VERTICAL

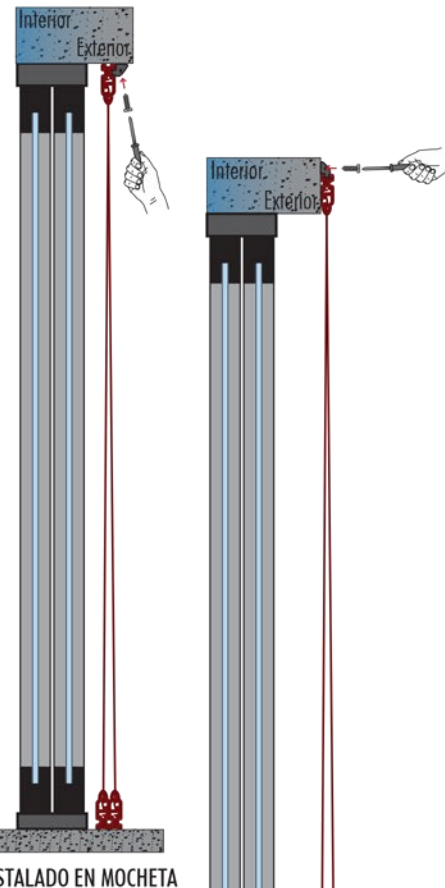

INSTALADO EN MOCHETA

INSTALADO DE FRENTE



**ENROLLABLE VERTICAL - frente mirando al exterior**

Se instala en una hoja de la abertura, del lado exterior, con el frente del cajón para afuera.

En casos excepcionales, se puede instalar en el interior.

**CORTE HORIZONTAL**

INSTALADO EN UNA HOJA + CAÑO ADICIONAL O FELPA (entre la guía y la hoja corrediza)

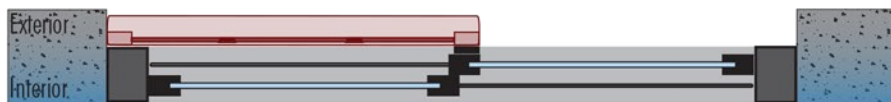

Exterior - En una hoja + caño adicional o felpa

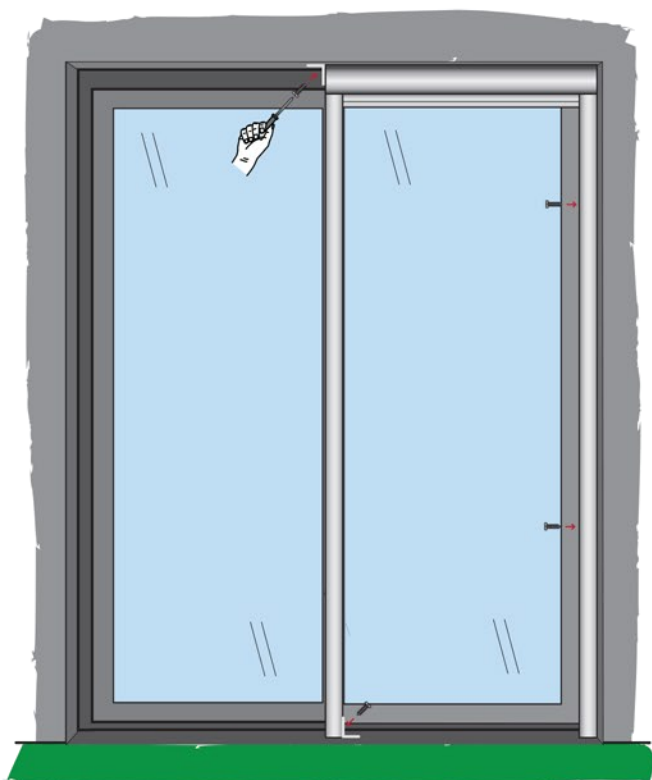

**CORTE VERTICAL**



CAÑO ADICIONAL O FELPA

INSTALADO UNA HOJA + CAÑO ADICIONAL o FELPA

Exterior - En una hoja + caño adicional o felpa

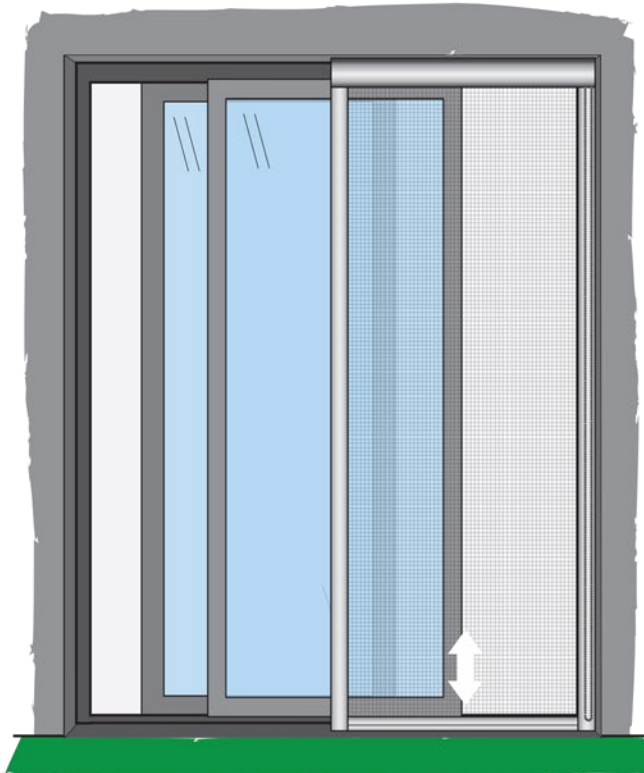

ENROLLABLE HORIZONTAL

Se instala en una hoja de la abertura, del lado exterior.

CORTE HORIZONTAL

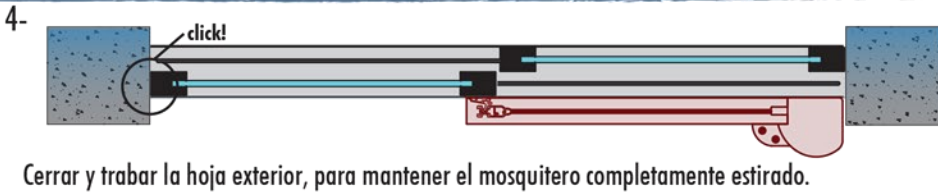
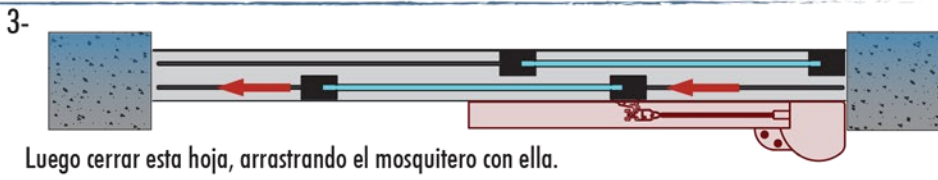
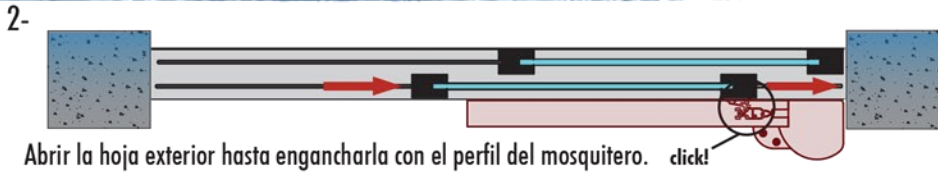
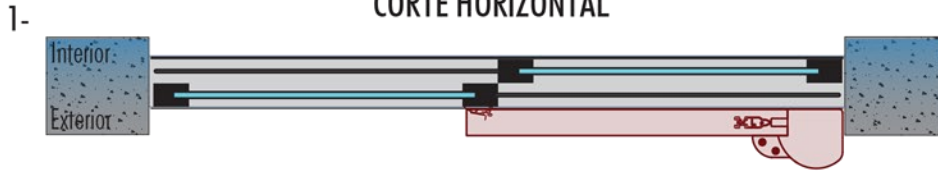

CORTE VERTICAL

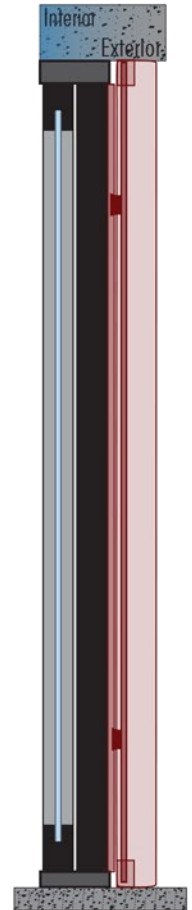

Exterior



Exterior

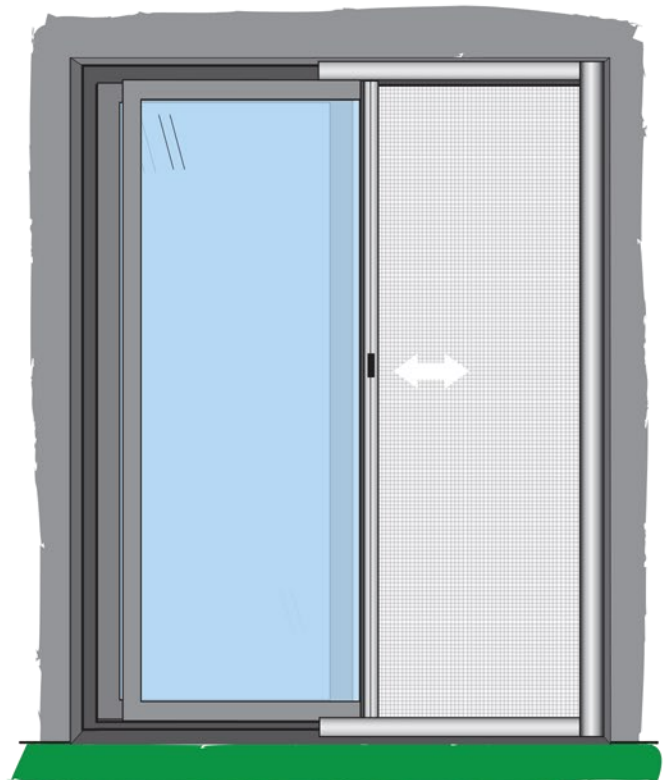

**ENROLLABLE HORIZONTAL MANUAL**

Se instala en una hoja de la abertura, del lado exterior, con el frente del cajón para afuera.

En casos excepcionales, se puede instalar en el interior.

**CORTE HORIZONTAL**  
INSTALADO EN UNA HOJA

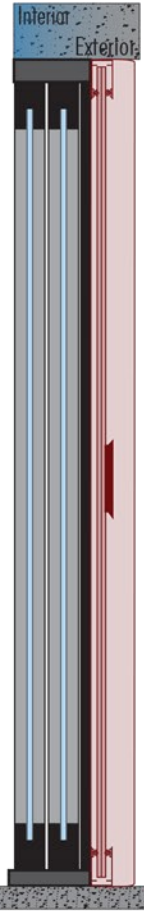
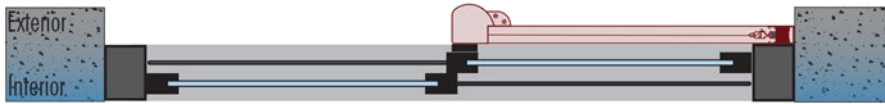

INSTALADO UNA HOJA  
+ CAÑO ADICIONAL o FELPA

Exterior - En una hoja



Exterior - En una hoja

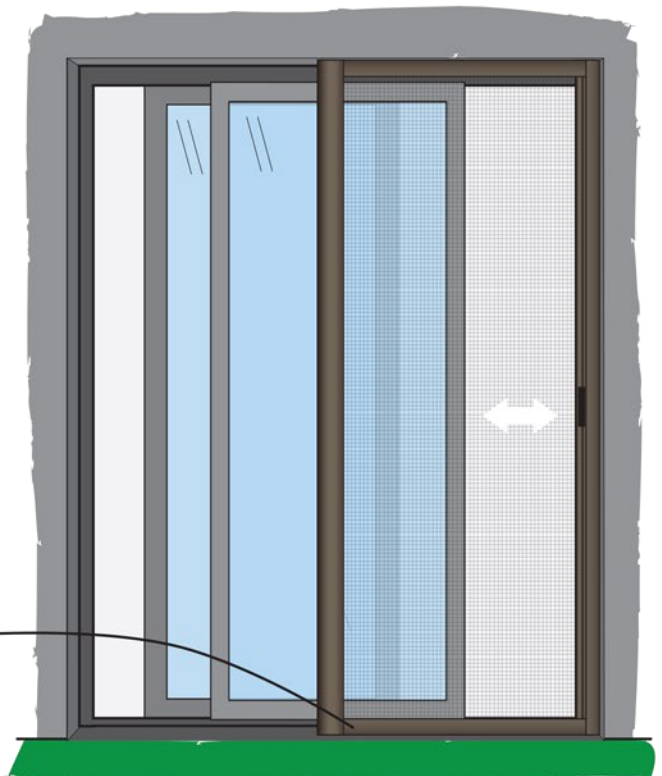

GUÍA INFERIOR DE 42 mm

PLEGABLE DE 40 mm HORIZONTAL - En 1 sola hoja

- Medida máxima por mosquitero: 1800 x 2500 mm
- La altura de cada puerta mosquitera debe ser siempre mayor en al menos 200 mm a la medida del ancho
- Se instala en el exterior .

CORTE HORIZONTAL

En puerta de 2 hojas corredizas

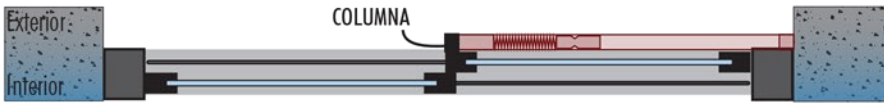

En puerta de 3 hojas corredizas

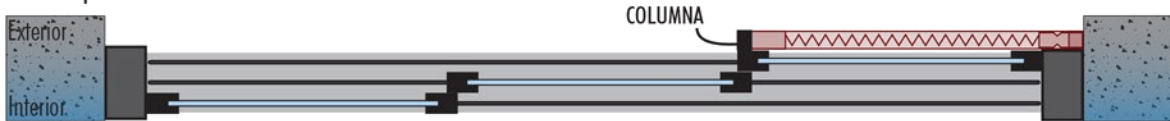

CORTE VERTICAL

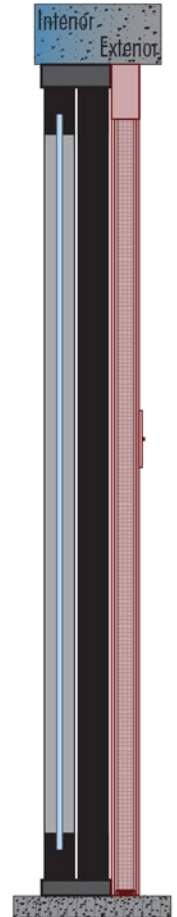

Exterior

COLUMNNA



Exterior

COLUMNNA

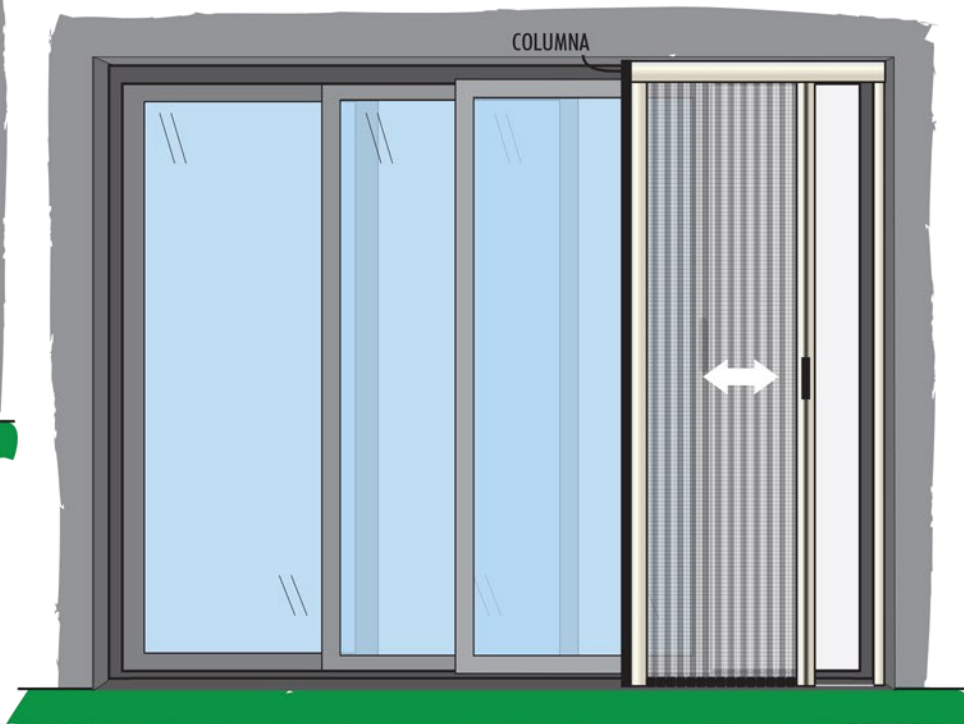

PLEGABLE DE 40 mm HORIZONTAL - En toda la abertura

CORTE HORIZONTAL

OPCIÓN 1 - Ancho total menor a 1800 mm

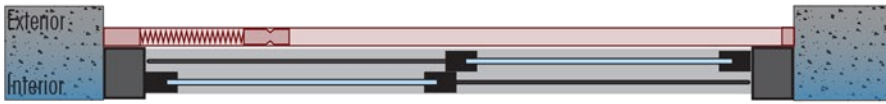

OPCIÓN 1 - Ancho total máximo: 3600 mm

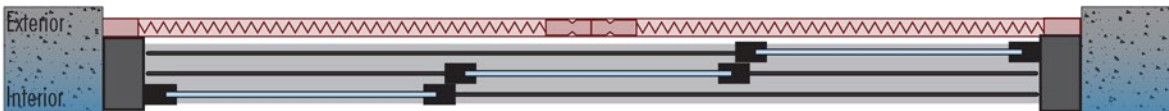

CORTE VERTICAL

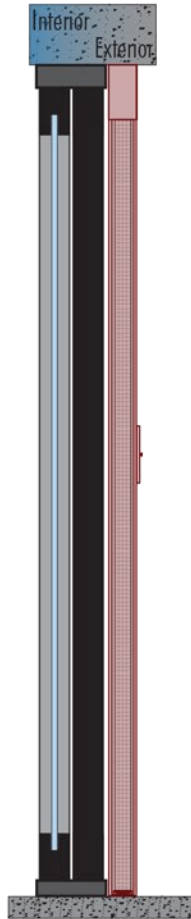

Exterior - Ancho total menor a 1800 mm

Exterior - Medidas máximas 3600 x 2500 mm

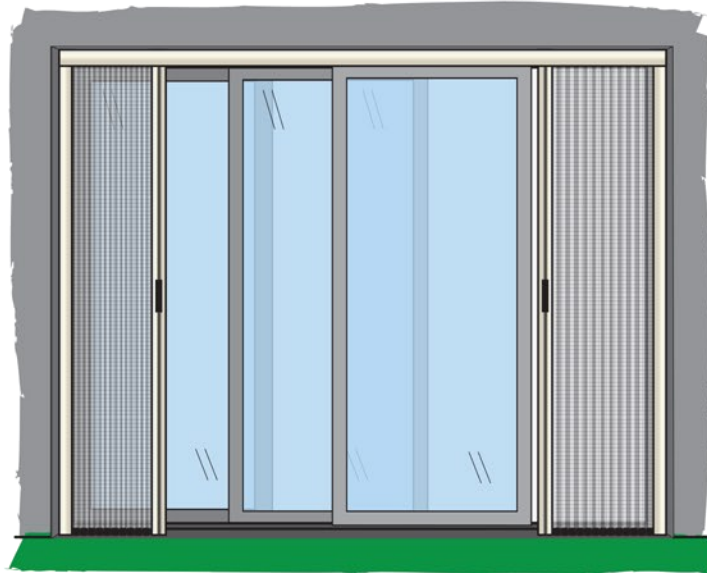
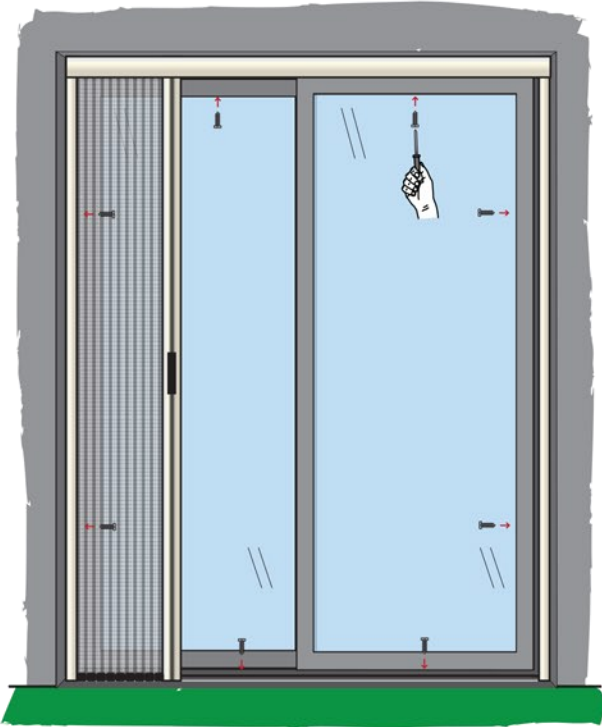

Exterior - Medidas máximas 3600 x 2500 mm

Exterior - Ancho total menor a 1800 mm

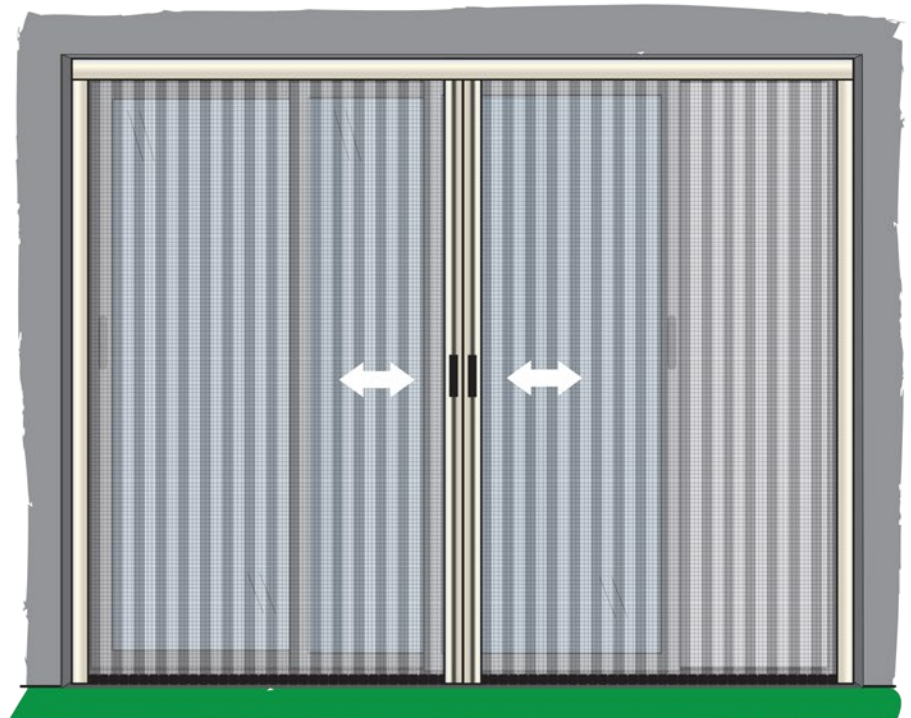
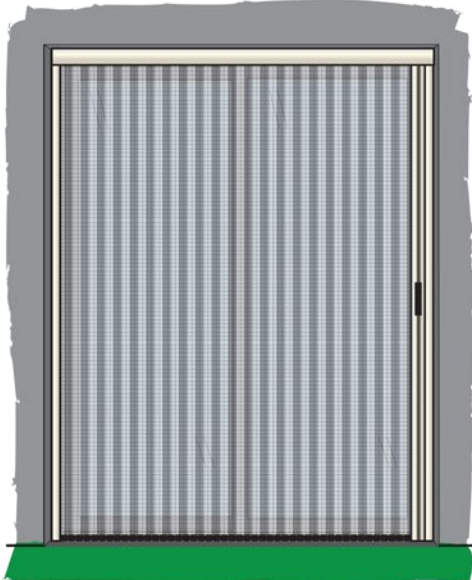

PLEGABLE DE 40 mm HORIZONTAL - En toda la abertura

CORTE HORIZONTAL

OPCIÓN 2

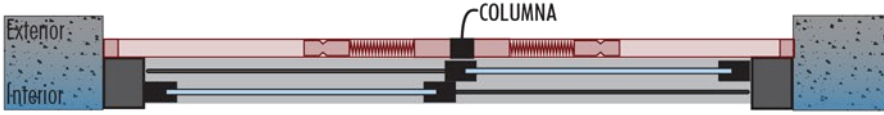

OPCIÓN 2

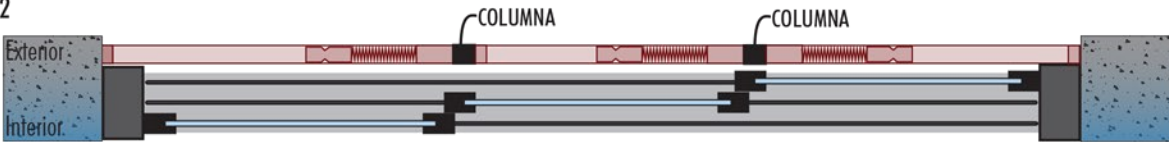

CORTE VERTICAL

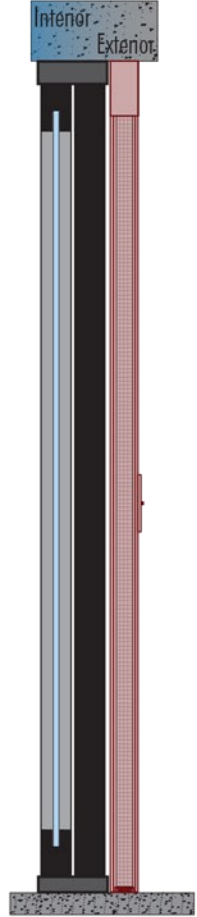

Exterior

COLUMN

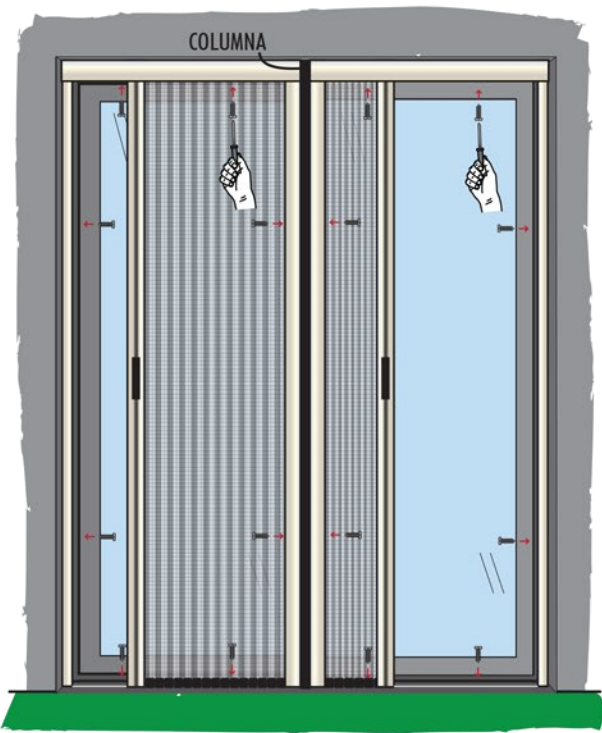

Exterior

COLUMN

COLUMN

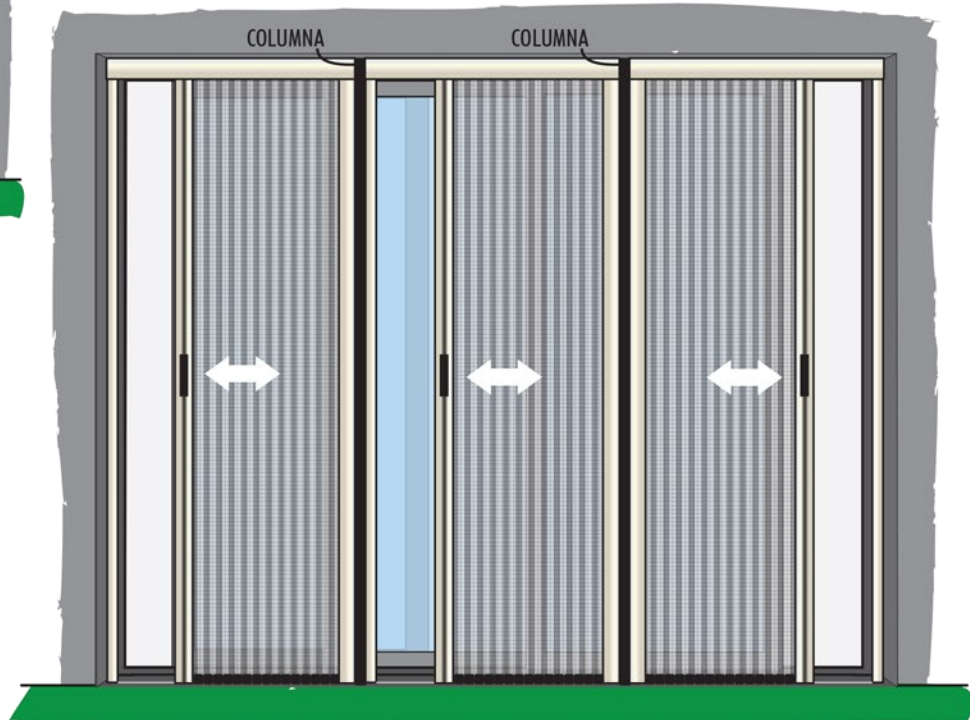

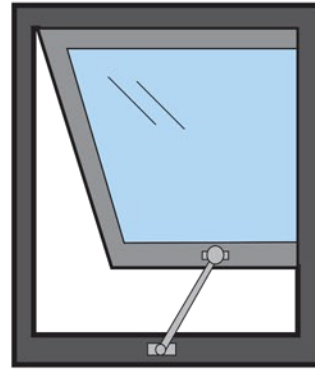
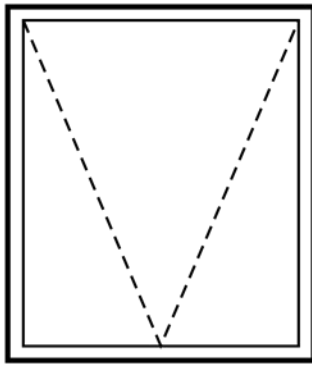

EN 2 TIPOS DE INSTALACIÓN DE LA ABERTURA: A EJE DE PARED y AL FILO DE PARED

EJE DE PARED

La instalación ideal de la abertura es a EJE DE PARED lo que genera una mocheta interna donde instalar el mosquitero enrollado en el interior, sin utilizar caños adicionales.

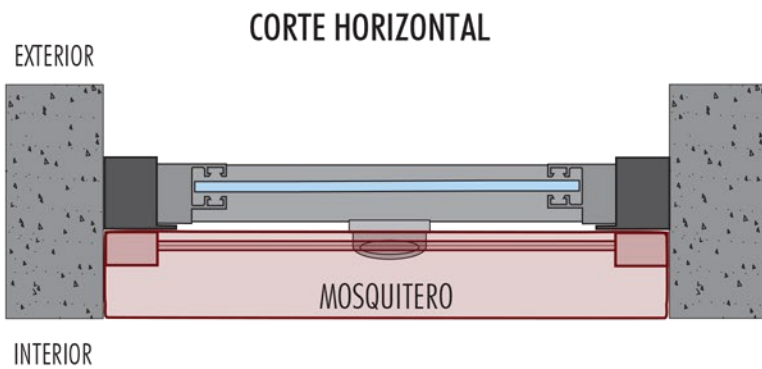

VENTANA CERRADA  
MOSQUITERO ENROLLADO

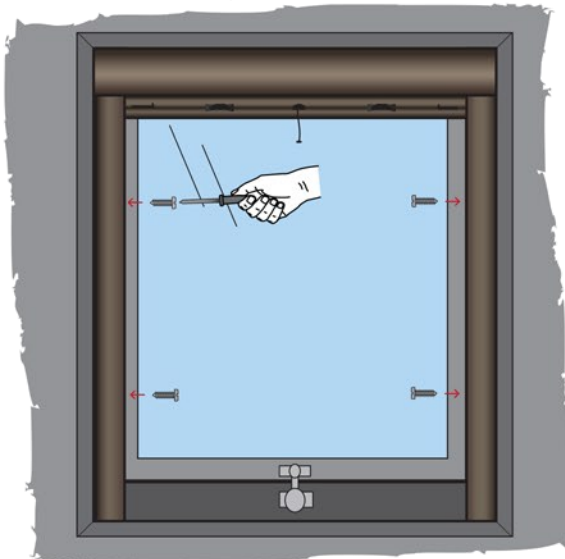

CORTE VERTICAL

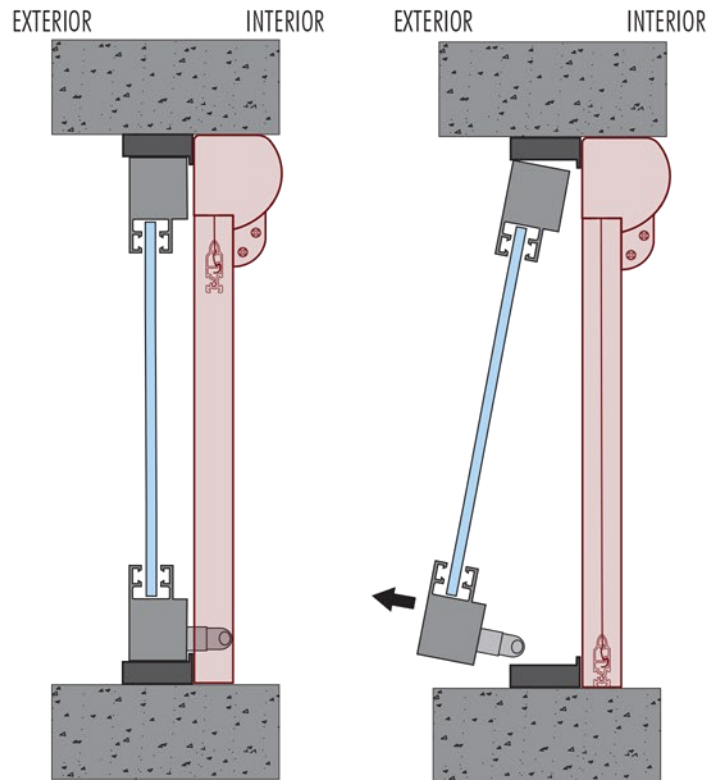

VENTANA ABIERTA  
MOSQUITERO DESPLEGADO

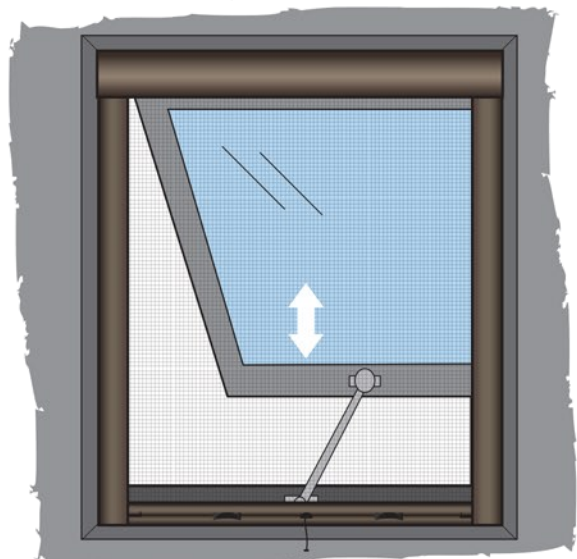

ENROLLABLE VERTICAL - frente mirando al exterior

Cuando la abertura está instalada a filo interno de pared, el mosquitero enrollable se instala en el interior de frente, con un caño adicional en la parte inferior (ajustable en obra).

CORTE HORIZONTAL

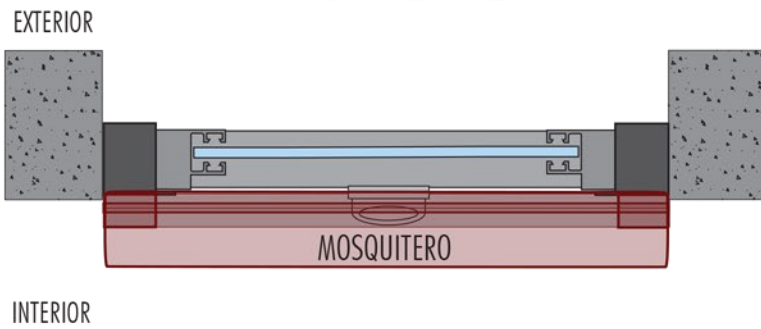

CORTE VERTICAL

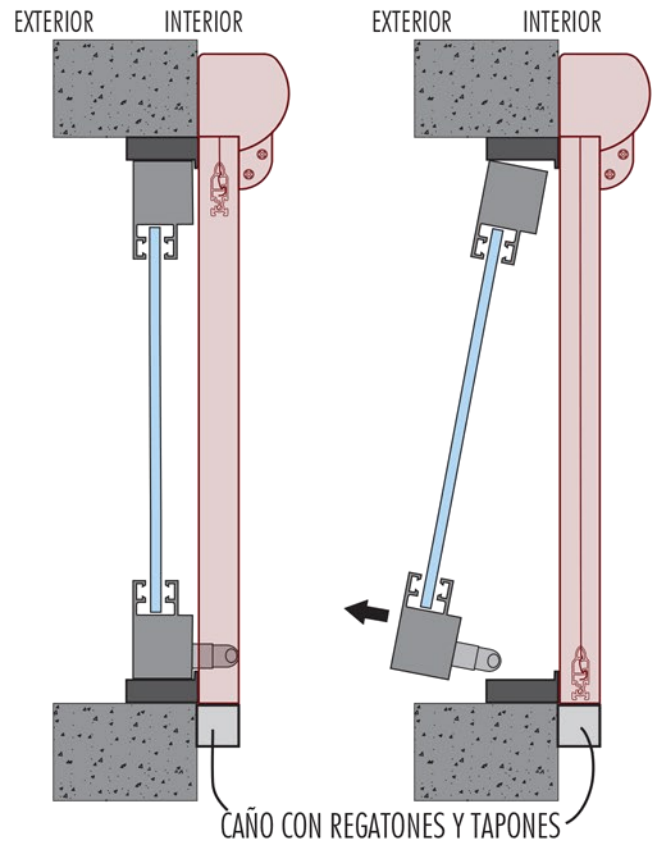

VENTANA CERRADA - MOSQUITERO ENROLLADO

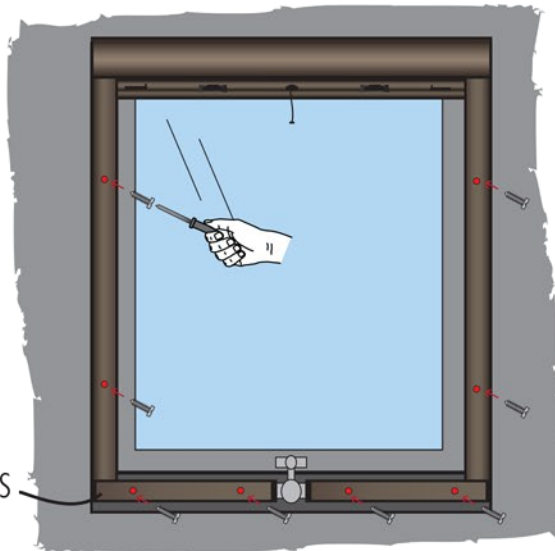

VENTANA ABIERTA - MOSQUITERO DESPLEGADO

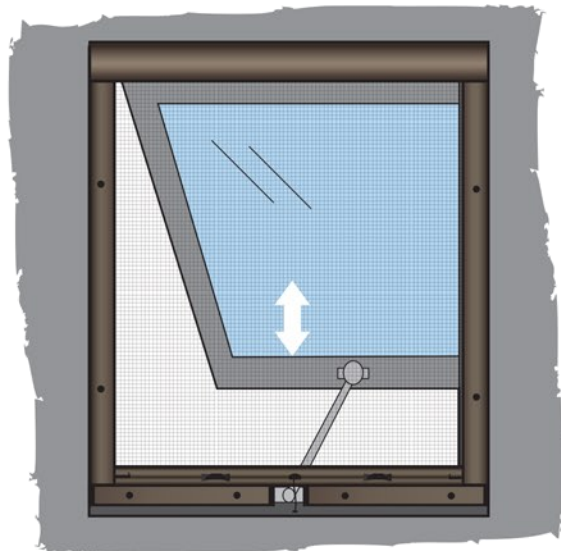

VENTANA CERRADA



CAÑO ADICIONAL CON REGATONES Y TAPONES



MOSQUITERO DESPLEGADO



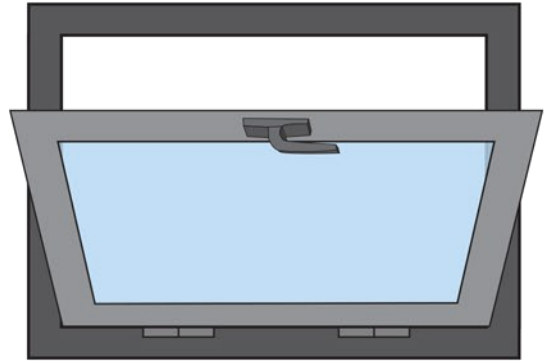
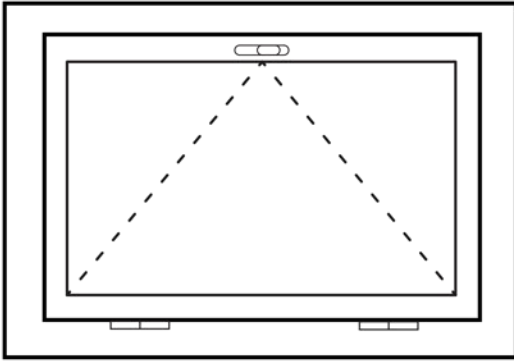

CON IMÁN

Se instala en la abertura completa, del lado exterior.

CORTE HORIZONTAL

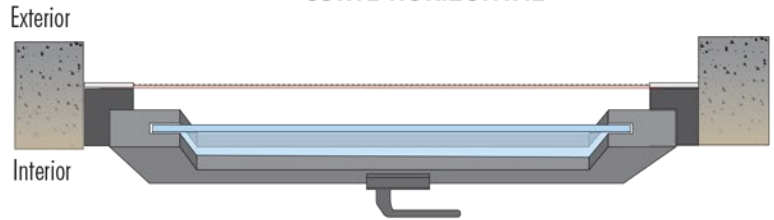

CORTE VERTICAL

